

SimMan Critical Care

DrugArm + LiveShock

User Guide

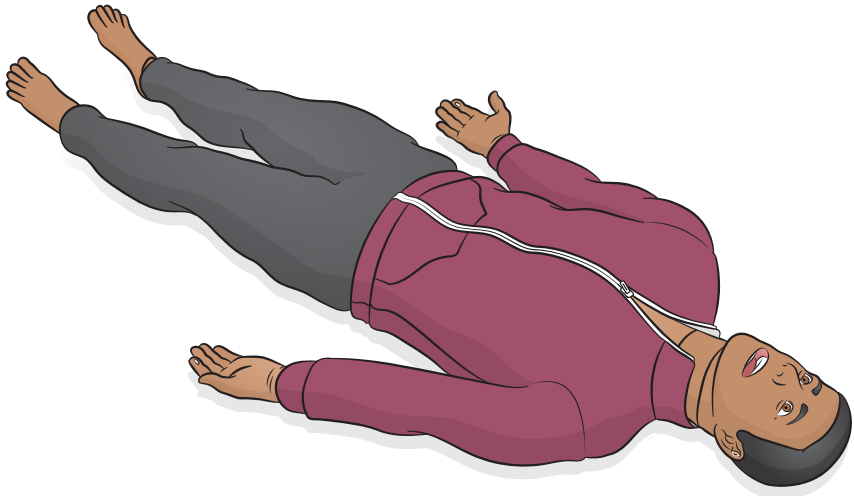

TABLE OF CONTENTS

Introduction	4
Items included	5
Features and skills	7
Features overview	7
Assessment capabilities	7
Immersive simulation	8
Airway and breathing	8
Clinical interventions	10
Cardiac and resuscitation	11
Injection sites	15
Drugs and IV	16
Articulations	17
Panels overview	18
Recommended sizes for clinical devices	19
Software	21
Operating software	21
Network connectivity	22
Power	26
Turning on the simulator	26
Charging the Patient Simulator	26
Setup batteries	28
Charging the battery	31
Prepare for simulation	32
Arm	32
Torso	43
Head, Neck and Airway	47
Prepare simulated blood & fluids	51
Leg	55
Maintenance	59
Torso	59

Arm	66
Head, Neck and Airway	71
Leg	79
General care and cleaning	83
General patient simulator care	83
Cleaning after use	83
IV Arm	84
Cleaning monthly	84
Clothing	85
Servicing	85
Always perform a service	85
Preventative maintenance	85
Cleaning the blood system	85
Cleaning the fluid system	88
Accessories	90
Trauma modules	90
Transport and storage	95

INTRODUCTION

SimMan Critical Care (SimMan CC) is a patient simulator that simulates various physiological conditions and medical scenarios.

It is intended for healthcare professionals training on a wide range of clinical and assessment skills. It can also be used with real clinical equipment.

SimMan CC can be used with LLEAP and Laerdal Simulation Home. More information on compatible software is available in the [Operating Software \(p. 21\)](#) section.

SimMan CC has an Advanced Lung Module (ALM) installed, refer to the ALM and LLEAP IngMar-plugin [user guide](#) for additional information.



CAUTION

Do not mix articulated and drug recognition arms.



NOTES

- *Read the Important Product Information booklet before use.*
- *Read the SimMan 3G PLUS Quick Setup Guide (QSG) for more information on usage.*
- *See Laerdal's Global Warranty for terms and conditions. For more information visit laerdal.com.*

ITEMS INCLUDED

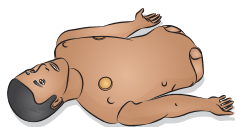

1

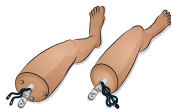

2

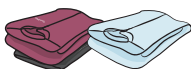

3



4



5

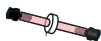

6



7



8



9



10

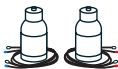

11



12

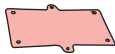

13

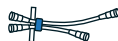

14



15



16



17



18



19



20



21



22



23



24

1. Upper torso	14. Catheter extension
2. Legs	15. IV bag
3. Clothes	16. Cricothyroid tape
4. Male & female genitalia	17. Tibia pads & bone (x3)
5. ID band	18. Pelvis IM pads (x2)
6. Inline filter blood (x2)	19. Pneumothorax, bladder (x2)
7. ECG/Defib tightener (x5)	20. Important Product Information
8. Blood pressure cuff	21. SPO ₂ probe
9. Neck skin (x3)	22. RFID kit
10. Blood concentrate and airway lubricant	23. Tools
11. Fill and drain bottles	24. External power supply
12. Wounds kit	
13. Chest drain pleura (x6)	



NOTE

Visit www.laerdal.com for accessories overview.

FEATURES AND SKILLS

Features overview

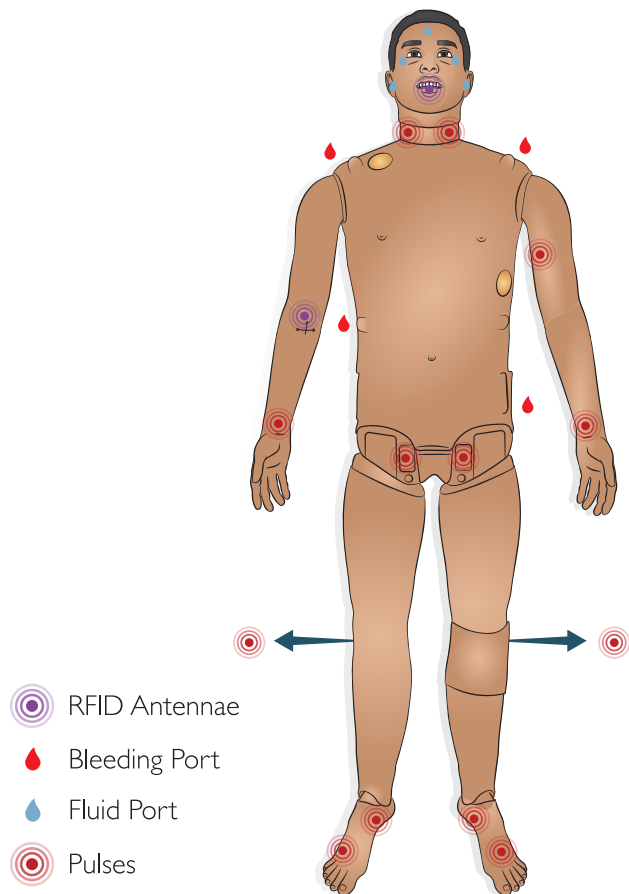

Assessment capabilities

- Automatic Non-Invasive Blood Pressure (NIBP)
- Carotid, brachial, radial, femoral, popliteal and pedal pulses
- SpO₂ monitoring
- Configurable eye, eyelid and pupil settings

- Heart, lung, bowel and vocal sounds
- RFID Technology for automatic recognition of drugs and airway devices.
- Auto measurement of volume and concentration for drugs and IV fluids.

Immersive simulation

- More diverse patient representation
- Fully articulating arms and legs
- Palpable skin and anatomical landmarks
- Anatomically correct male and female genitalia
- Bleeding simulation
- Secretion simulation

Airway and breathing

- Configurable airways (including tongue edema, pharyngeal swelling, laryngospasm)
- Head tilt, jaw thrust and chin lift
- Spontaneous breathing
- Chest rise and fall
- An embedded set of lungs, or Advanced Lung Module (ALM), which allows for actual exhalation.

Airway interventions

The airway is anatomically modelled as far as the bronchia and can be manipulated by a learner:

- Head tilt/Chin lift
- Jaw thrust with articulated jaw
- Cricoid pressure and manipulation
- Simulated suctioning (oral and nasopharyngeal)



NOTE

- *If the tongue fallback feature is enabled, head tilt is required to open the airways for mask ventilations.*

The following information is automatically registered in the SimMan CC simulation session:

- Detection of proper head position
- Jaw thrust
- Pneumothorax decompression
- Ventilations
- Stomach distension

Nasal Cannulation

Nasal cannulation is possible with standard equipment.



WARNING

Do not supply oxygen.

Artificial respiration

Artificial respiration of SimMan CC can be achieved by the following methods:

- Bag-mask ventilation
- Orotracheal intubation
- Nasotracheal intubation
- Transtracheal intubation

Refer to [Recommended sizes of clinical equipment \(p. 19\)](#) for more SimMan CC compatible devices.



NOTES

- *Do not spray lubricant directly into the airway.*
- *Use of a malleable stylet is recommended; ensure it does not extend beyond the ET tube.*
- *Exhaled CO₂ can be detected with a CO₂ detection device attached to an ET tube.*

Airway complications

The following airway complications can be controlled by the instructor in LLEAP:

- Tongue edema
- Pharyngeal swelling
- Laryngospasm

- Decreased cervical range of motion
- Trismus
- Can't intubate/Can ventilate
- Can't intubate/Can't ventilate

Surgical airway

It is possible to simulate an emergency airway through the cricothyroid membrane in SimMan CC. Refer to [Replacing Cricothyroid Tape and Neck Skin \(p. 71\)](#).



CAUTIONS

- *Do not put biological or other materials in the simulator's airways.*
- *Only use Manikin Airway Lubricant. Any other lubricant not approved by Laerdal may cause damage to the airways and lungs of the simulator.*
- *Refer to the Important Product Information booklet for further cautions related to the Patient Simulator airway.*



NOTES

- *In LLEAP the airway and breathing status for the current simulator is shown in a window. Settings for lung resistance, compliance, and other parameters can be made in the ALM plugin software. Refer to LLEAP Help Files, Advanced Lung Module and LLEAP IngMar-plugin software user guide for further information.*
- *Refer to LLEAP Help Files for complete breathing and airway blockage functionality and operating information.*
- *Incorrect positioning will pass air through oesophagus, causing distention of the abdomen.*

Clinical interventions

- Bag Valve Mask (BVM) ventilation
- Laryngeal Mask (LMA) placement
- Oral, nasal and endotracheal intubation
- Suctioning (oral & nasopharyngeal)
- Cricothyrotomy
- Pneumothorax Needle Decompression and Chest tube insertion
- Intramuscular (IM), Intravenous (IV) and Intraosseous (IO) injection
- Catheterization

Cardiac and resuscitation

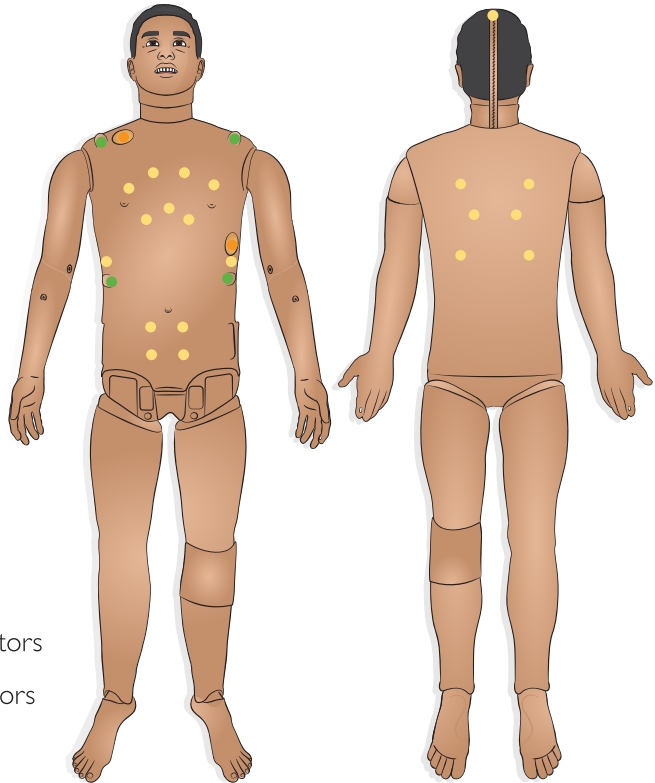

- Defib Connectors
- ECG Connectors
- Speakers

- LiveShock skin for defibrillation options
- Cardioversion
- ECG rhythm monitoring
- External pacing
- CPR capable



NOTES

- *SimMan CC provides CPR measurement and feedback compliant with AHA 2020 guidelines.*
- *LLEAP provides real-time feedback on the quality of depth, release and frequency of CPR. CPR compressions generate palpable pulses, blood pressure wave form, and ECG artefacts.*
- *Refer to LLEAP Help Files for more information. SimMan CC has been verified for use with the LUCAS 2 Chest Compression System.*

Cardiac interventions overview

SimMan CC allows for defibrillation in accordance with 2020 international guidelines for CPR. The LiveShock skin enables connection with a live defibrillator and for the following procedures to be performed:

- Defibrillation
- Synchronised cardioversion
- External pacing with or without capture

Defibrillation

The energy levels and number of shocks required for automatic conversion are set in each simulation Patient Case.

Ensure the defibrillator pads are in good condition and are correctly placed on the defibrillator plates.



WARNING

During live defibrillation, the defibrillator and Patient Simulator may present a shock hazard. All standard safety precautions must be taken when using the defibrillator on the Patient Simulator. Read the Important Product Information booklet for more Cautions and Warnings.



CAUTION

Do not defibrillate on the ECG connectors on the Patient Simulator. This will damage the Patient Simulator.



NOTES

- *Always follow the safety instructions from the defibrillator manufacturer when using the defibrillator on the Patient Simulator.*
- *To prevent overheating during defibrillation, do not exceed a defibrillation sequence of 3 shocks in 45 seconds followed by 1 minute of CPR.*
- *After 30 minutes there must be at least 15 minutes pause in defibrillation before starting a new sequence. Do not repeat this for more than a 4-hour period.*

Refer to [LiveShock Upgrade Kit](#) on how to install a new skin.

Cardioversion and external pacing

Synchronised cardioversion and external pacing with or without capture

SimMan CC enables the attachment of real electrodes for ECG rhythm monitoring at 4 sites with 3-lead ECG. 12-lead ECG display.

LLEAP features an extensive ECG library and records cardiac rhythms.

Refer to LLEAP Help Files for further information.

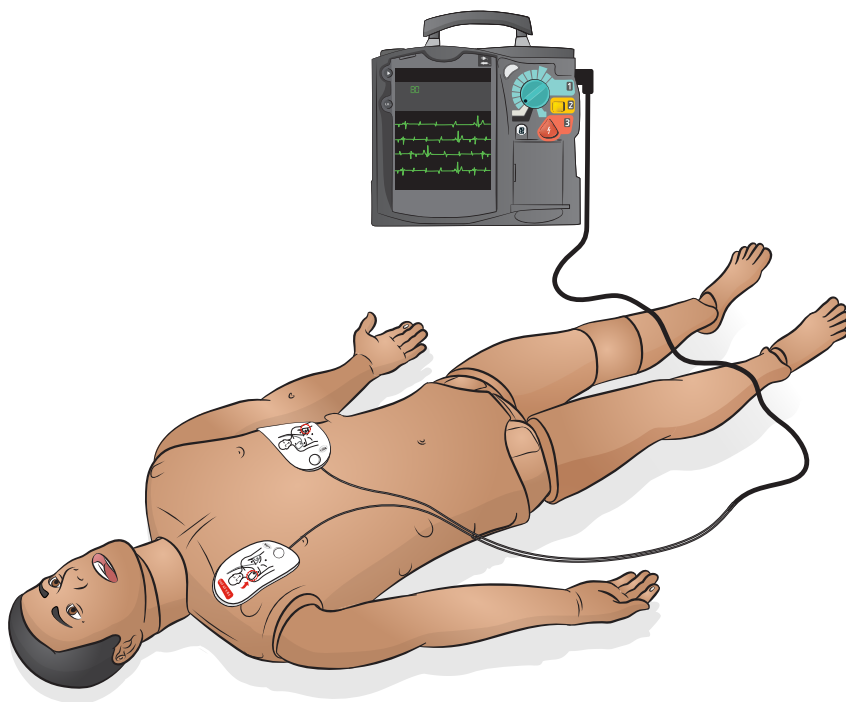

Injection sites

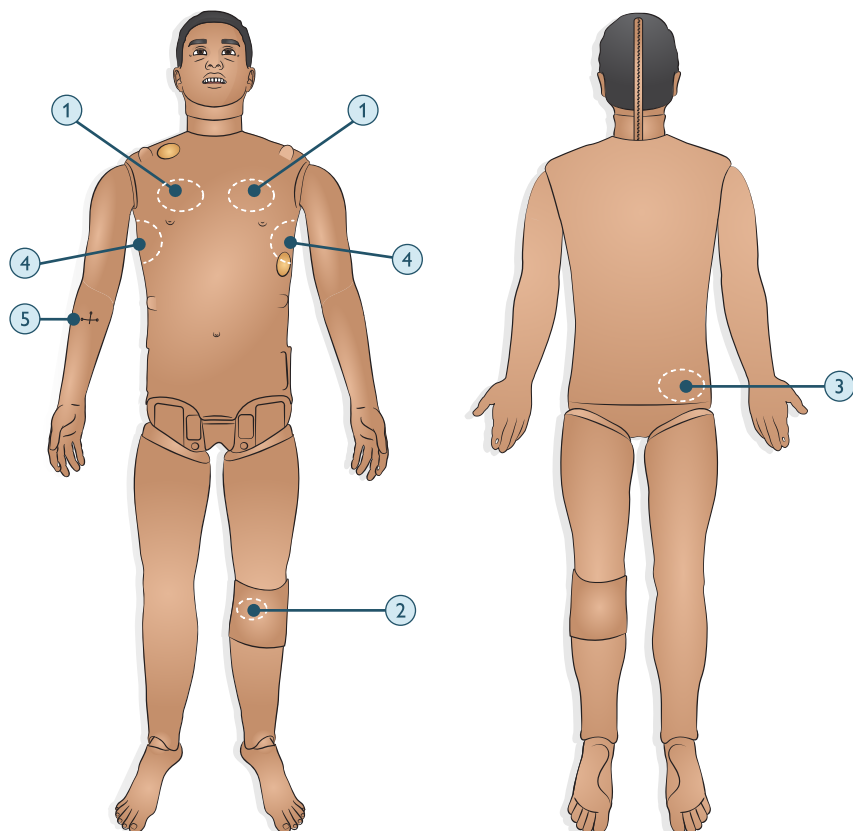

1. Tension pneumothorax with needle decompression can be performed at the bilateral mid clavicle line, second intercostal space.
2. Intraosseous (IO) simulation with needle insertion is possible through the left tibia.
3. Intramuscular (IM) injections can be simulated in the upper hip.
4. Chest tube insertion can be simulated at left or right mid-axillary line in the fourth and fifth intercostal space.
5. Intravenous (IV) fluids can be simulated on the right arm.

Drugs and IV

Drugs used by the scenario and corresponding drug concentrations can be registered manually by the instructor in the Event window in LLEAP or automatically, if you use RFID tags. For further information, see LLEAP Help.

Patient Monitor Features – Drugs

- Train-of-Four (TOF)
- in N₂O, et N₂O
- Anesthesia agents
- Lab reports

User-replaceable items, Spare Parts

- IV catheter (US and International versions)
- IV fluid filter
- Intra-muscular pad

Articulations

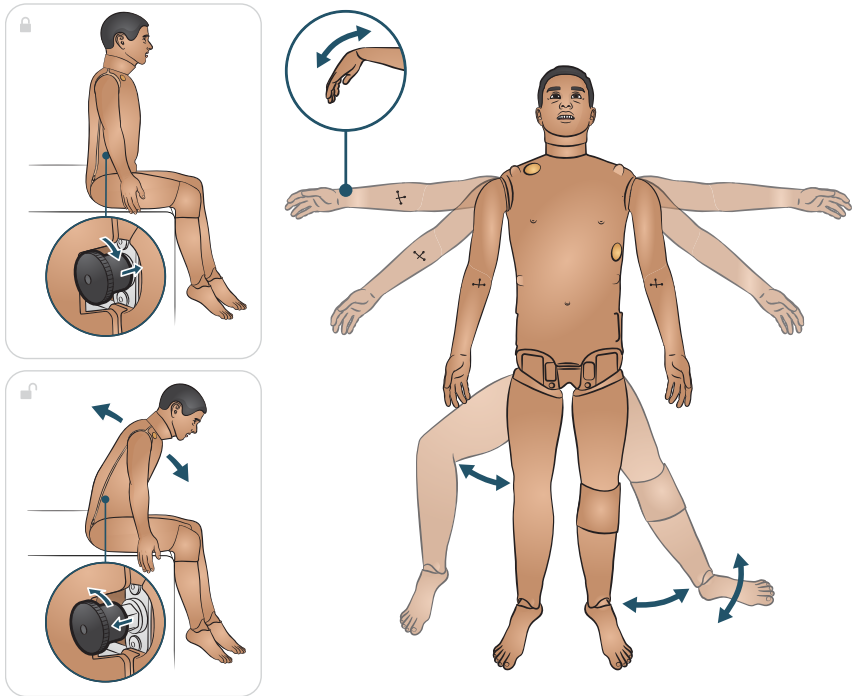

The Patient Simulator has a range of limb and joint articulation providing immersive patient handling.

Joint	Range of Mobility
Neck	3-axis movement of the head
Shoulder	At least: 160° flexion of arm 30° extension of arm 70° abduction of arm 90° medial rotation
Elbow	Fixed, no mobility
Thumbs	Free mobility
Wrist	Radial flexion and ulnar flexion
Lumbar	1-axis rotation

Joint	Range of Mobility
Hip Joints	3-axis rotation
Knees	1-axis rotation
Ankles	1-axis rotation

Panels overview

Power panel

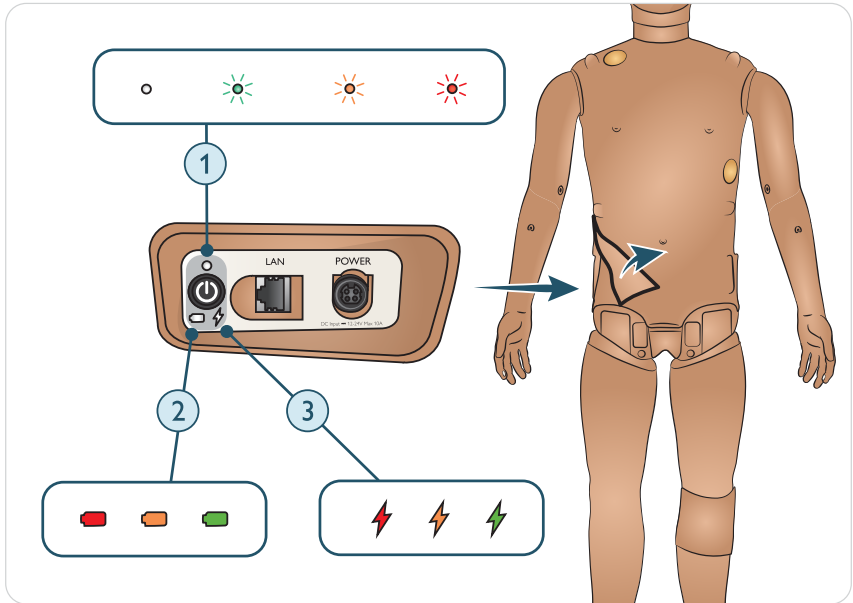

1. Power status	2. Battery status	3. Charge status
No Light - Power Off	Red - 0 - 20%	Red - Not charging (check batteries)
Green - Power On	Orange - 20-70%	Orange - Charging in Progress
Orange - Start-up	Green - 70-100%	Green - Charging almost complete
Flashing Red - Power Save		

Fluid panel

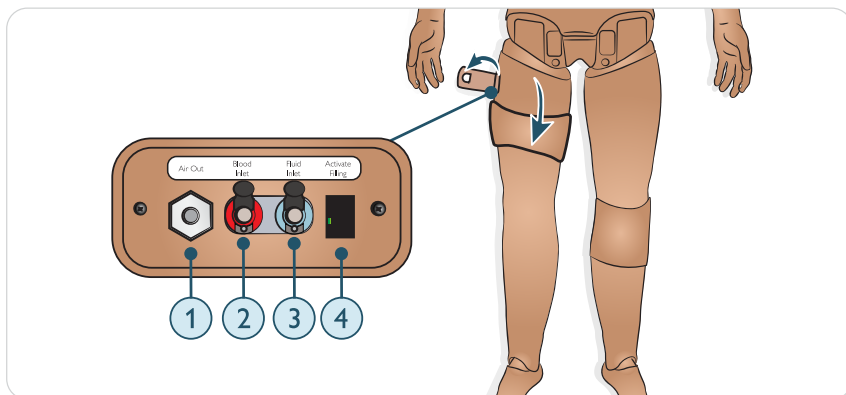

1. Air out
2. Blood inlet
3. Fluid inlet
4. Activate filling

Recommended sizes for clinical devices

Device	Recommended Size
Oropharyngeal Airway (OPA)	3
Nasopharyngeal Airway (NPA)	7
Endotracheal Tube and Laryngoscope Blade	7 to 8.5
i-gel Airway	4
King LTS-D/LT-D	4
Combitube	37 Fr (small adult)
Laryngeal Mask Airway (LMA)	4 or 5
Tracheostomy Tube	8 Fr
Airway Suctioning	Rigid Adult Size
Thoracostomy Needle	22 G
Chest Tube	14-28 Fr

Device	Recommended Size
Urinary Catheter Size	16 Fr
IM Needle	21 G (maximum)
Mask (for ventilation)	Laerdal Adult Mask 4 to 5+
Intraosseous (IO) Access	Tibial: BIG Automatic Intraosseous Device, 15 G EZ-IO, 15 G x 1", 1.8mm x 25mm Jamshidi ® Illinois Bone Marrow Aspiration/ Intraosseous Infusion Needle. 18 Ga. 9/16" (14mm)-1 ½" (38mm)



CAUTION

Incorrect use of larger devices can damage the IO bones and/or internal components. The smaller size is recommended.

SOFTWARE

Operating software

Laerdal Simulation Home

Laerdal Simulation Home is a platform for healthcare professionals used to access simulation resources, courses, and tools for training and education.

Laerdal Simulation Home is located in the Laerdal Medical folder under the Windows start menu.

LLEAP, LLEAP Help files and other Laerdal programs related to patient simulation are accessed through Laerdal Simulation Home.



NOTE

Refer to the [Opening Laerdal Simulation Home](#) video.

LLEAP (Laerdal Learning Application)

LLEAP is the instructor's application from where the simulation session is run, controlled, and monitored. Installed on a laptop, PC or tablet, LLEAP can be operated in Automatic or Manual mode.

Automatic mode is used for pre-programed scenarios while Manual mode allows the instructor full manual control over the simulation session.

Running simulations in Manual mode generally requires some medical expertise to create clinically sound simulations.



NOTE

Check the LLEAP help files for more information on features usage and connectivity.

Other applications

The following applications are available in conjunction with the simulation sessions:

- The Patient Monitor application emulates a typical hospital patient monitor. It is the learner's console and can be set up and controlled by the instructor, as well as by the learner, through on-screen touch menus.
- Voice Conference Application (VCA) transmits all vocal sounds used during simulation. It enables the instructor to communicate through the simulator during the session.
- Session Viewer; SimView Server and SimView Mobile are applications that record video and patient monitor screen captured during simulation, in addition to providing an interface to debrief your session. After a session has ended, log files generated in LLEAP are transferred and merged with the video files in Session Viewer, SimView Server, SimCapture and SimView Mobile for the debriefing.
- License Manager for handling program licenses.
- Simulator Firmware Network Wizard for updating the firmware of the simulators or troubleshooting network problems.
- SimDesigner is used for configuring your own pre-programed scenarios. It can also be used to analyze and print out a graphical representation of a scenario. SimDesigner must be installed to allow conversion of legacy instructor application files to LLEAP compatible file formats.
- Network Selector in Laerdal Simulation Home helps users connect LLEAP and Patient monitor to a wireless network and even host a network (Windows Hosted Network).
- LLEAP IngMar plugin software - SimMan Critical Care: For more information about this software refer to Advanced Lung Module and LLEAP IngMar-plugin software user guide.

For a full overview of all applications and their help files, start Laerdal Simulation Home.

Network connectivity

SimMan CC provides several network connectivity options to ensure uninterrupted sessions wherever a simulation is taking place.

Option 1: Enterprise network

The standard network connectivity is delivered by the integrated USB Wi-Fi dongle. The dongle connects to a local enterprise IT network for improved speed and signal strength.

Option 2: Router

If a local or ad-hoc network is required, a router (Laerdal or user's own) can be used.

Option 3: Mobile router

A portable, battery-operated router can be used for outside simulation sessions where an enterprise network may not be available.



NOTE

For more information on network setup, connectivity and available routers contact Laerdal Help Desk.

Wi-Fi or wired setup

The Patient Simulator can have a Wi-Fi setup or wired setup, depending on simulation requirements.

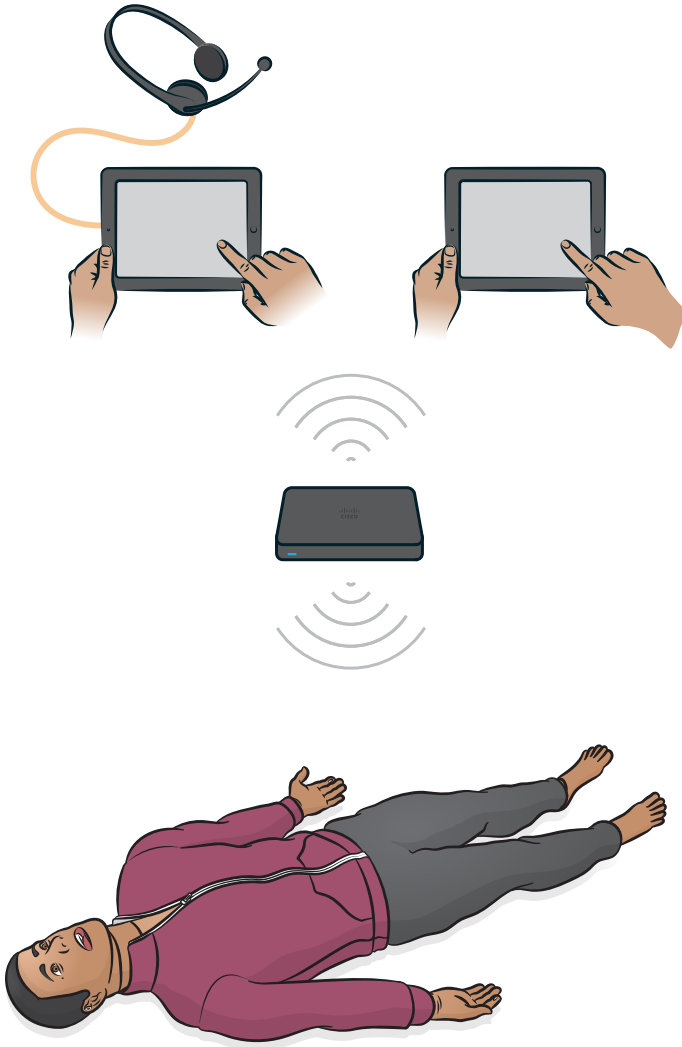

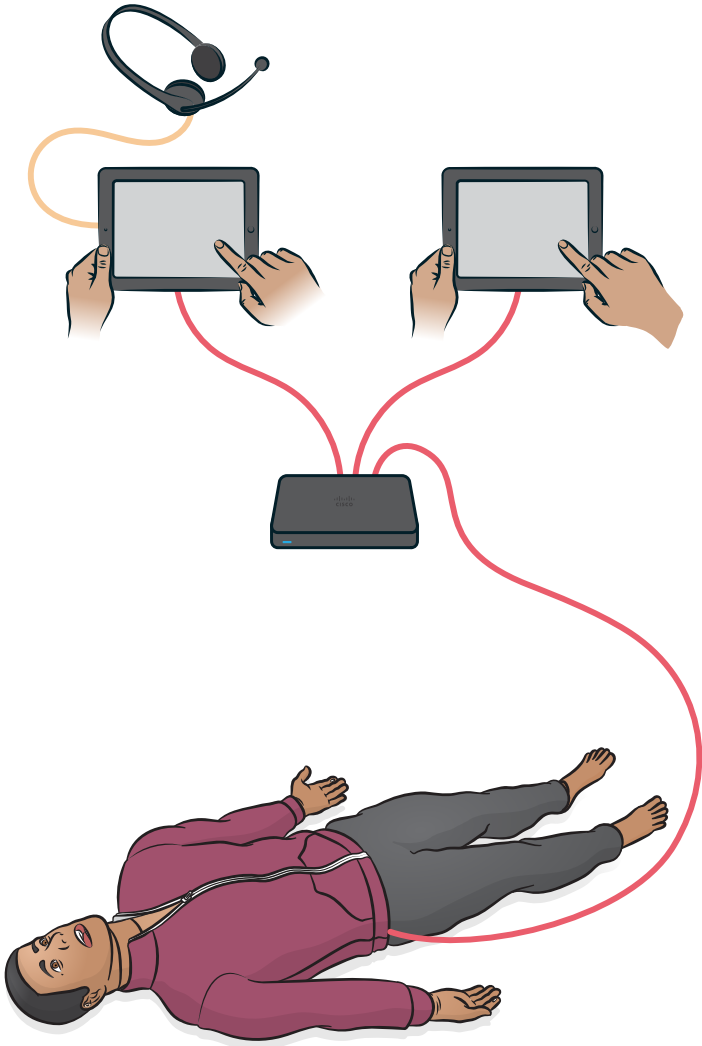

POWER

Turning on the simulator

Press the power button.

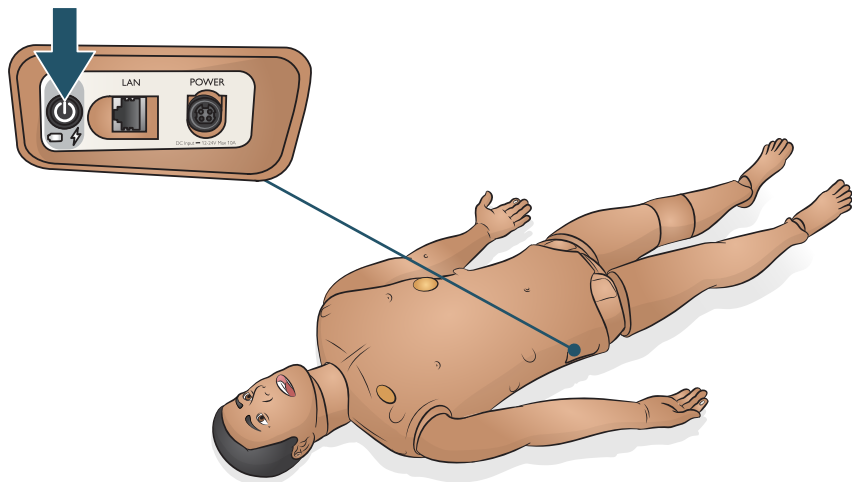

- The power status indicator turns orange.
- The Patient Simulator says "Simulator started".
- The eyes blink and there is visible chest rise.

Charging the Patient Simulator

- Battery charging time is approximately 3 hours. Once fully charged, the batteries can last for up to 4 hours.
- Plug the Patient Simulator to the external power supply. Turn the Patient Simulator on to charge the batteries.
- Battery and power status can be viewed on the Patient Simulator's power panel and the Simulator Status window in LLEAP.

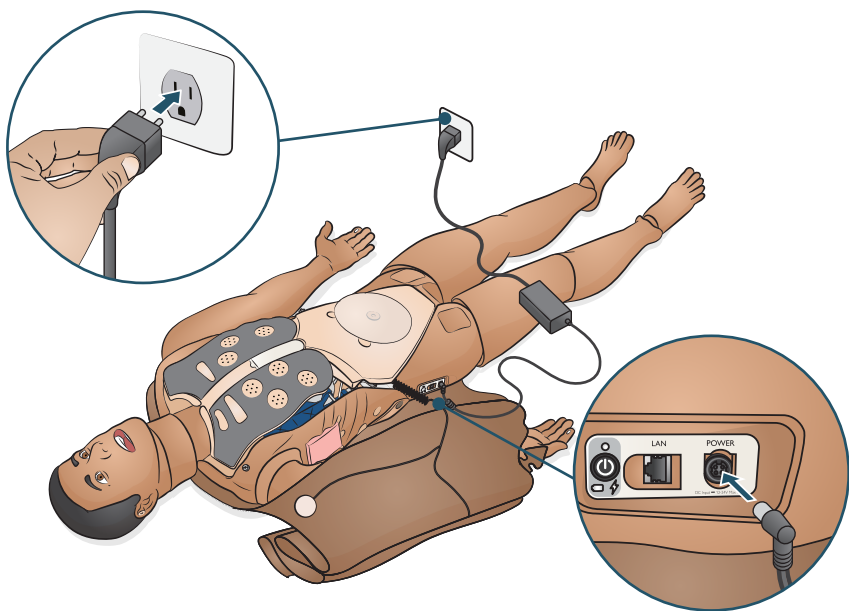

CAUTIONS

- Do not run the Patient Simulator for more than 1 minute on a single battery.
- After the Patient Simulator is turned off, wait 20 seconds before restarting or the Patient Simulator may not function properly.
- Never store fully charged batteries for longer than a month.
- Only use the SimMan Family (except SimMan ALS) external power supply and batteries.
- The external battery charger is for indoor use only.
- Never store the batteries inside the Patient Simulator.



NOTES

- On approximately every 30th charge cycle, drain the battery completely before recharging. To drain the batteries, run the Patient Simulator on both batteries until automatic shutdown.
- The Patient Simulator will automatically shut down if battery temperature rises above 60 °C (140 °F) or the remaining charge falls below 6% on one of the two batteries.
- If both batteries are removed while the simulation is paused, the Patient Simulator will shut down and simulation data will be lost.
- Refer to the Important Product Information for further information.

Setup batteries

SimMan CC is powered by 2 Laerdal Lithium Ion (Li-Ion) batteries. Always use 2 batteries together to power the Simulator and ensure that they are connected properly.

Ensure the Patient Simulator is switched off.

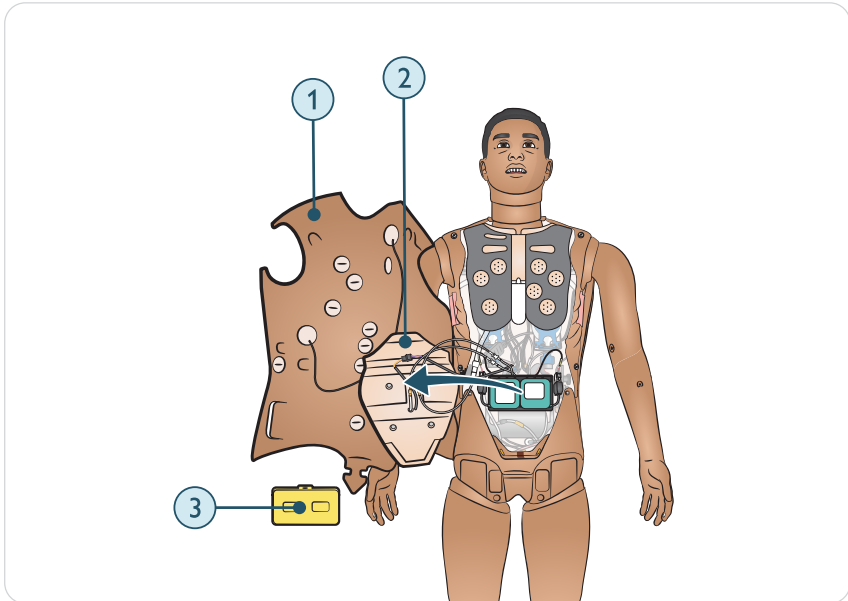

1. Before starting, follow the [Open the torso skin \(p. 59\)](#) procedure.

2. Move the stomach foam carefully to one side to avoid pulling on connecting tubes and cables.
3. Remove battery cover:

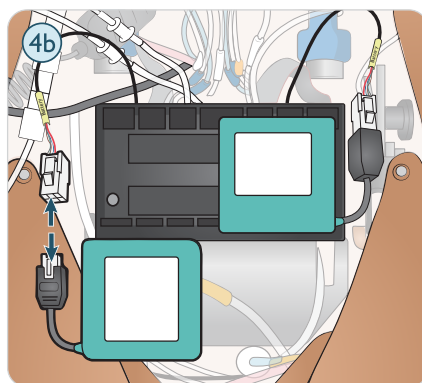
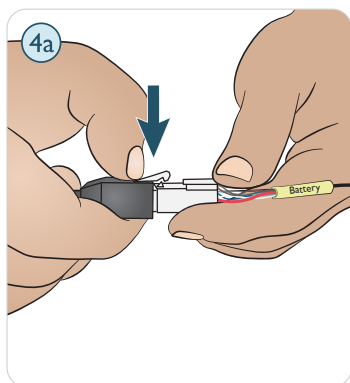

4. Disconnect the battery cable from the torso cable as shown.

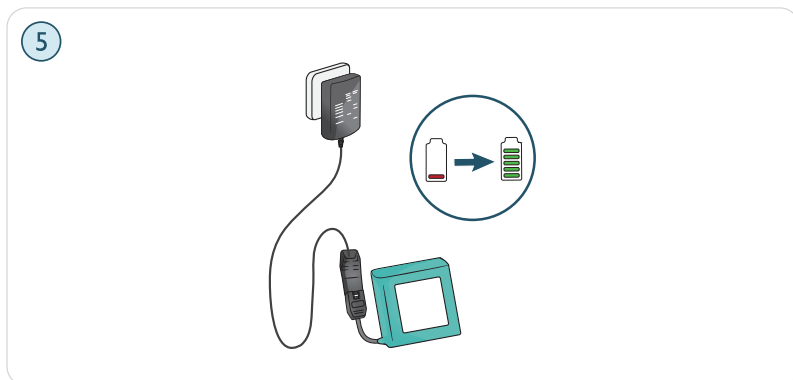

5. Charge battery

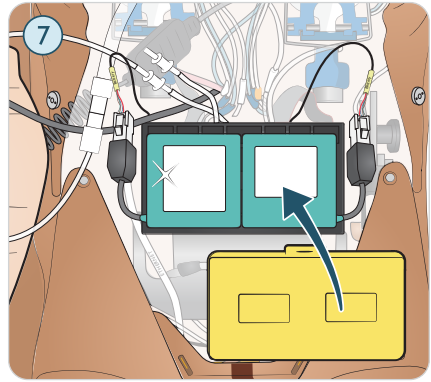
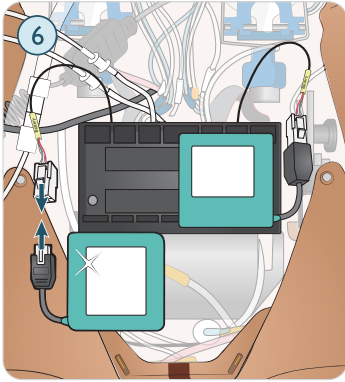

6. Insert battery and connect battery to the torso cable as shown.
7. Replace cover once battery/batteries are connected and in place.



WARNING

Inserting and connecting batteries incorrectly, short circuiting or exposure to fluids pose an explosion hazard.



CAUTIONS

- Ensure the LiveShock cable has been disconnected.
- Do not use the batteries if they are visibly damaged, malfunctioning or appear to leak electrolyte.



NOTES

- If both batteries are removed while the simulation is paused, the Patient Simulator will shut down and simulation data will be lost.
- If battery(ies) are damaged, dispose or recycle in accordance with local regulations, and replace with a new battery.

Refer to [Transport and Storage \(p. 95\)](#) for more information relating storing and transporting batteries.

Charging the battery

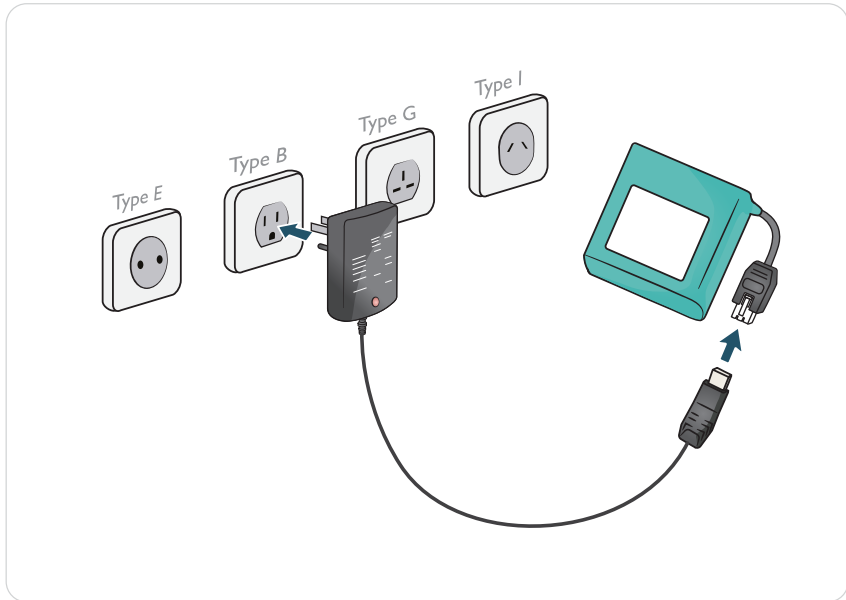

The Patient Simulator battery charger comes with 5 interchangeable international plugs which can be used to externally charge batteries outside of the Patient Simulator:



NOTE

The charger should only be used with Laerdal Li-ion batteries.

PREPARE FOR SIMULATION

Arm

IV catheters

The right IV arm comes with a US catheter type as default. This can be replaced with an international catheter type (commonly used in Europe) with an extra flush port.

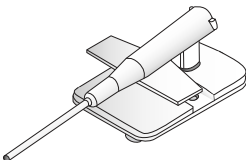
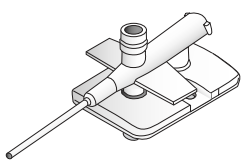
US catheter	International Catheter
	



NOTE

Remove arm skin before changing the catheter. Use caution when handling the Patient Simulator skins.

Charging IV Catheters



1. Unzip and fold down the IV arm skin to expose the IV catheter module.
2. Using a #4 Phillips screwdriver; unscrew the two screws of the module and pull the IV module out of the arm.
3. Disconnect the two fluid tubes from the IV module
4. Discard the old module and insert it into the IV arm.
5. Fasten the two screws and zip the skin back into place.

Identifying IV Catheter Sizes

The IV modules come with colored IV caps for US and International IV modules. This simulates different catheter sizes.

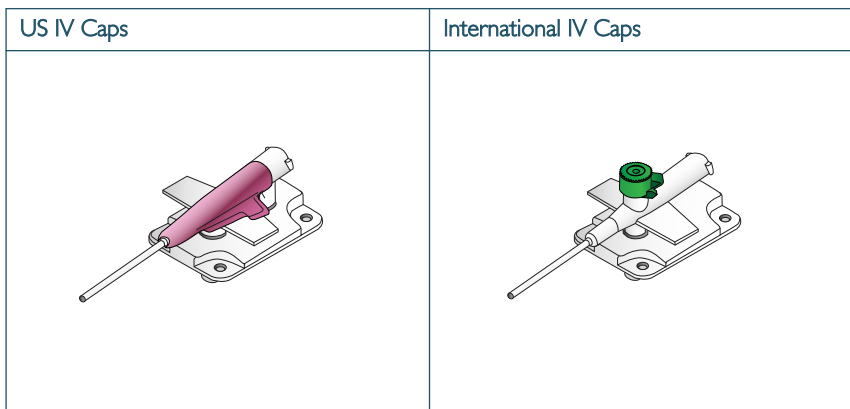

US IV Catheter Setup

Setup for drug administration

To administer simulated drugs using the RFID system, the SimMan CC US IV catheter comes with one inlet for drug administration.

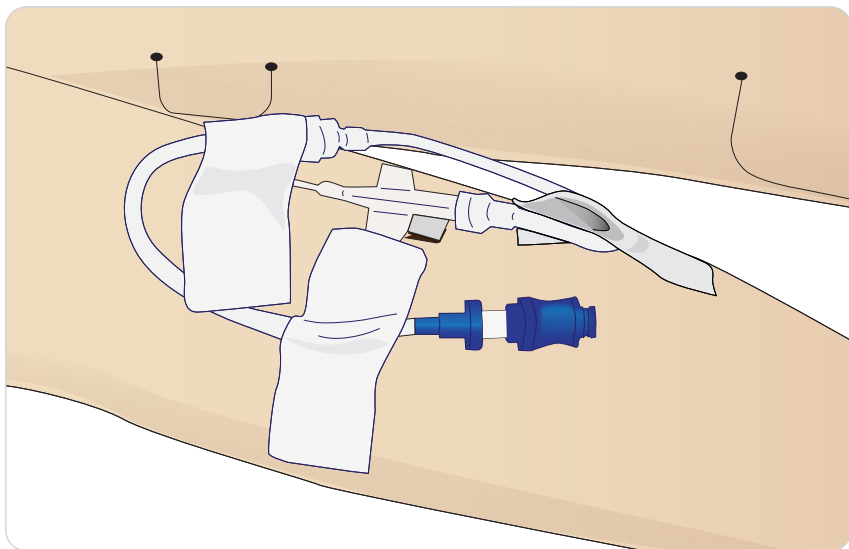

Setup for IV drip and drug administration

To simulate an IV drip, connect the international catheter and tube setup as shown.

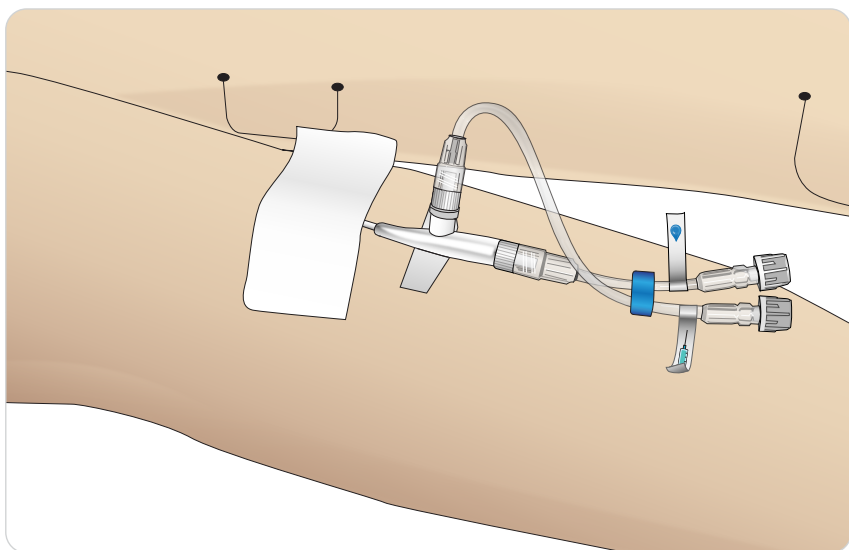

The drip port may also be used with fluids other than distilled water while only purified water should be used in the injection port.

For more information on connecting the US IV drip catheter; contact your local Laerdal service centre.

Administering IV fluids

To prevent clogging of the IV system, use only purified water to simulate IV drugs with SimMan CC.

Acceptable Types of Purified Water:

- Distilled water OR
- De-ionized water.

Do not apply force when administering drugs to the IV arm.

Priming the IV Arm System

It is essential to prime the IV arm before first session each day. Before administering any simulated drugs and to prevent backflow, inject purified water in a continuous stream into the IV system.

Major movement/transportation of the Patient Simulator can result in air pockets being introduced into the IV system and may require additional priming.

Draining Excess IV fluid

The IV fluid system is an open system. IV fluids are drained as they are administered.

Before Each Session

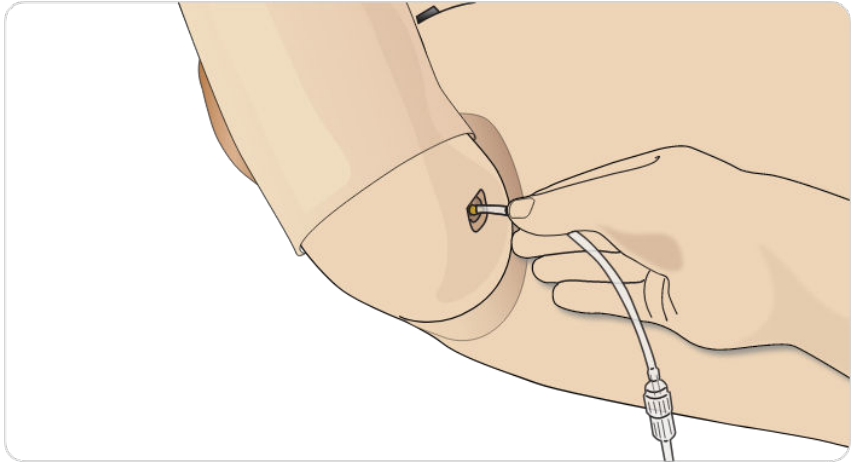

1. Attach the IV overflow tube to the fluid drain under the Patient Simulator's right arm.
2. Allow excess fluid to drain into a container during the simulation.

Calibrating the IV Arm Flowmeter in LLEAP

To calibrate the flow meter in the IV arm:

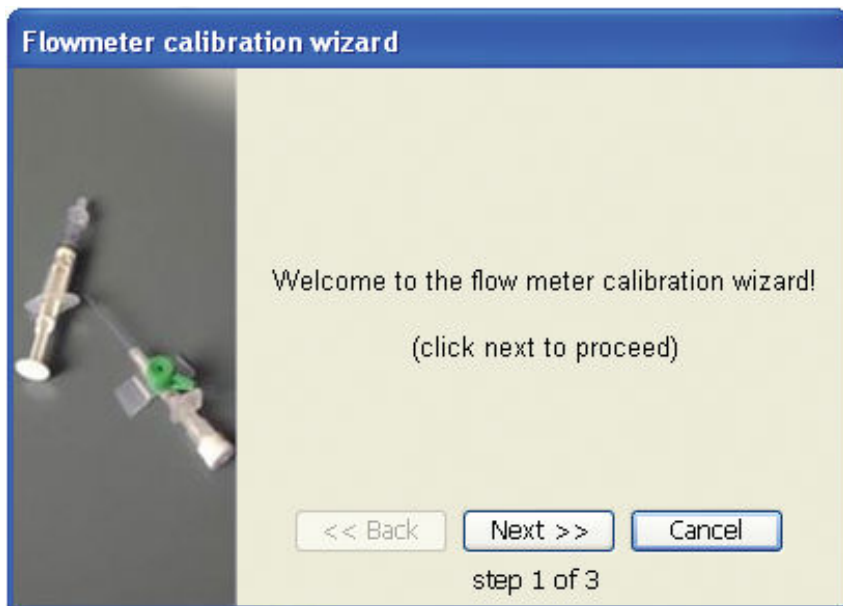

1. Click on the *Tools, Maintenance* menu in LLEAP, then select the *Calibrate IV flow meter* option.
2. Follow the on-screen instructions in the Flowmeter calibration wizard.

A confirmation message will appear if the calibration was successful.

RFID tag

The SimMan CC RFID (Radio Frequency Identification) system, features two antennae locations: one in the mouth and another in the right arm. Whenever a RFID tagged device comes within range of the antenna, it is automatically registered by the system. For automatic drug recognition to function, ensure that all syringes or devices carry an RFID tag.

RFID tagging Syringes / Airway Devices

The RFID tags come as part of the SimMan CC Drug and Airway Tag Kit. Tags are pre-printed with information to identify drugs, drug concentration or device names.

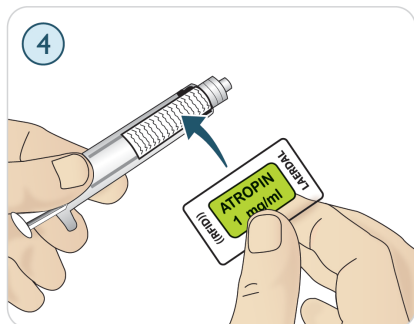
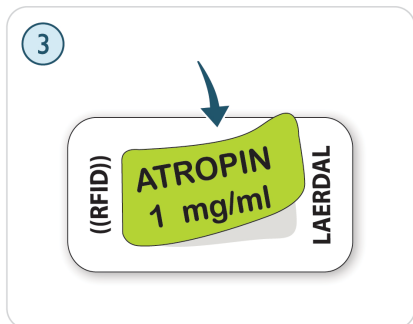
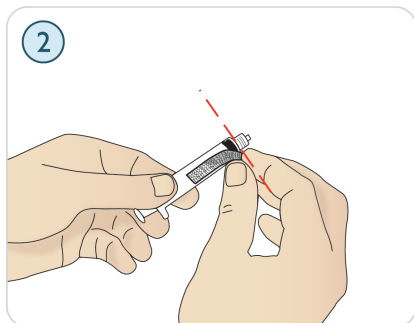

1. Attach a strip of hook and loop tape (i.e. Velcro) to the syringe or airway device of your choice.
2. If you are using stickers, place the RFID sticker on the pre-printed RFID tag.



NOTES

- When applying tags to syringes, ensure that the tag is as close as possible to the needle end.
- When applying tags to other devices, place them on the part of the device that is closest to the Patient Simulator.

You can choose to use your own drug labels on the RFID tags. Ensure that the drug identification and concentration is consistent with that of the RFID tag's coding.

Using RFID Tags

See the Instructor Mode help file for more information on how drugs and drug concentrations can be registered manually by the instructor.

RFID Tag use for Airway Devices

For reliable RFID recognition in the mouth region, ensure that the RFID tagged device is brought within range of the antenna. The range of the mouth antenna is approximately 10cm.

IV Setup for RFID Recognition

You can use your own equipment to set IV extension tubing. Keep in mind that the point of insertion must be within range of the antenna located around the IV port. If the point of insertion is out of range, drugs will not be registered.

See the correct and incorrect IV setup for US catheter below:

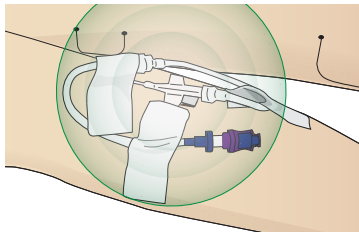
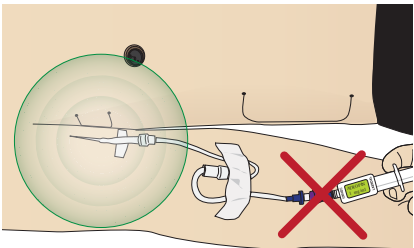
Correct	Incorrect
In range of antenna	Out of range of antenna
	

It may take some seconds before the RFID tag is registered.



NOTE

Only one RFID device can be registered at a time. Allow only one device at a time to come within range of the antenna.

Connecting the blood pressure cuff

The Patient Simulator is delivered with a specially adjusted blood pressure cuff. Connect the tube to the white BP connector at the side of the Patient Simulator before use.

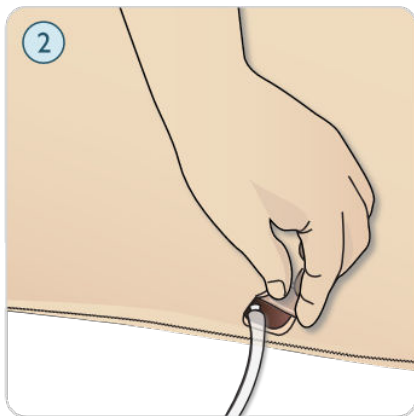

Calibration of BP in LLEAP

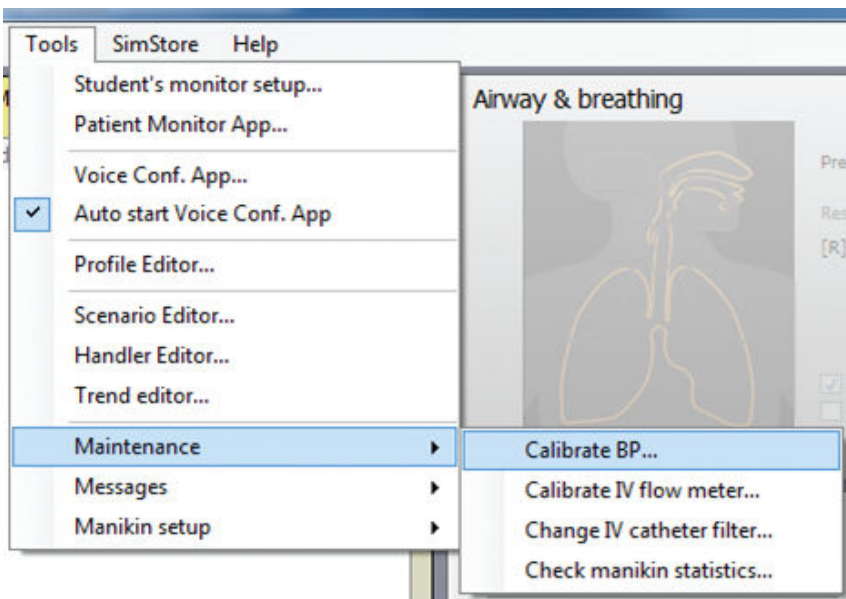

BP cuff calibration wizard



1. Select *Tools, Maintenance*, and choose *Calibrate BP*.
2. Follow the onscreen wizard instructions to perform the calibration.

SpO2 monitoring

The SimMan CC SpO2 probe is made up of a light diode and light sensor. When the beam between the diode and sensor is broken, the Patient Monitor Application registers that the SpO2 probe is connected.

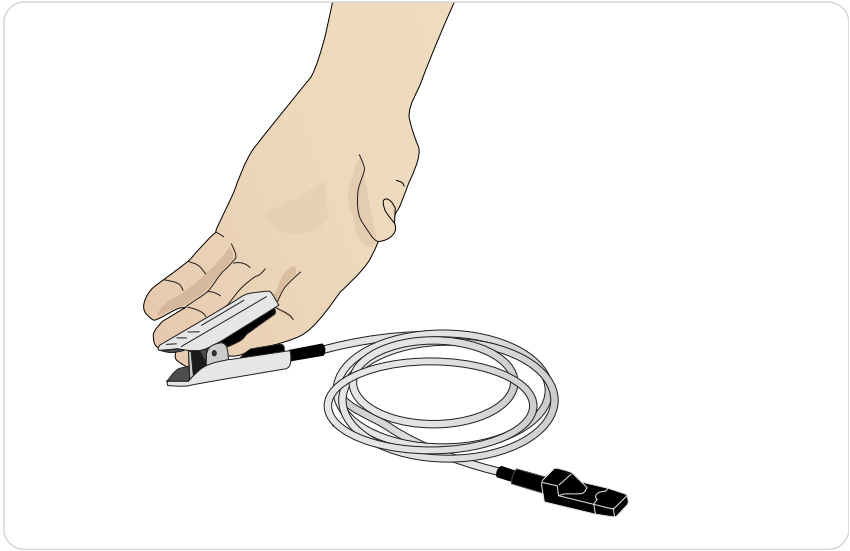

1. Connect the probe's USB plug to the Patient Monitor PC.
2. The probe can be placed on any suitable area on the Patient Simulator; Ensure that the probe is always firmly fixed in position.

Torso

Prepare Air/CO₂

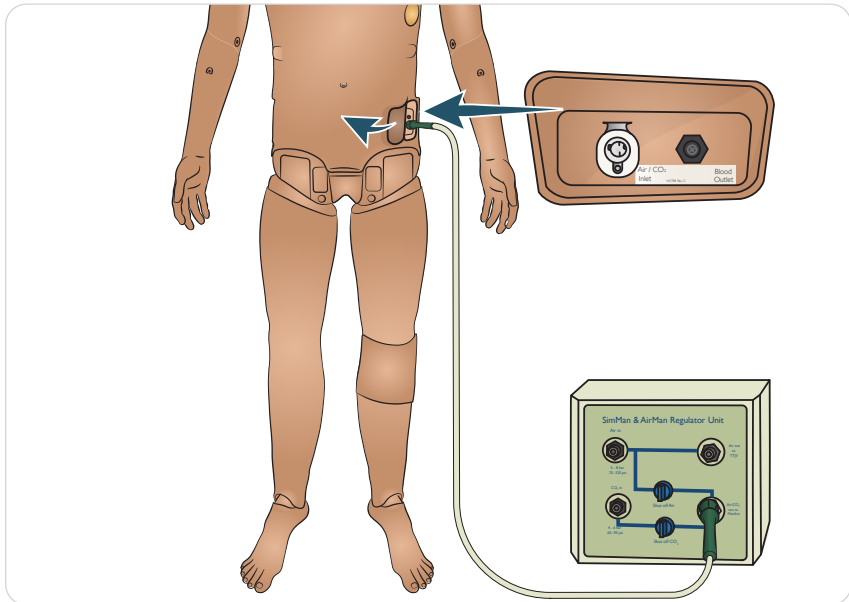

The Air/CO₂ panel is located on the left side of the Patient Simulator's torso. Access the panel by lifting up the skin flap and removing the protective covering.

If the Patient Simulator is required to exhale CO₂ with each ventilation, connect an external CO₂ supply. An external supply of compressed air can be connected when the Patient Simulator is stationary over extended periods.

1. Connect a suitable CO₂/external air source to a Laerdal external compressor or regulator panel.
2. Connect a Laerdal double-lumen Air/CO₂ tube from the external compressor or regulator panel to the Air/CO₂ inlet on the panel.



NOTES

- Exhaled CO_2 can be detected with a CO_2 detection device.
- Refer to the *Important Product Information* booklet for information on maximum external air and CO_2 connection limits.
- For more information on external compressors and regulator panels compatible with SimMan CC, contact your local Laerdal representative.

Attaching a wound

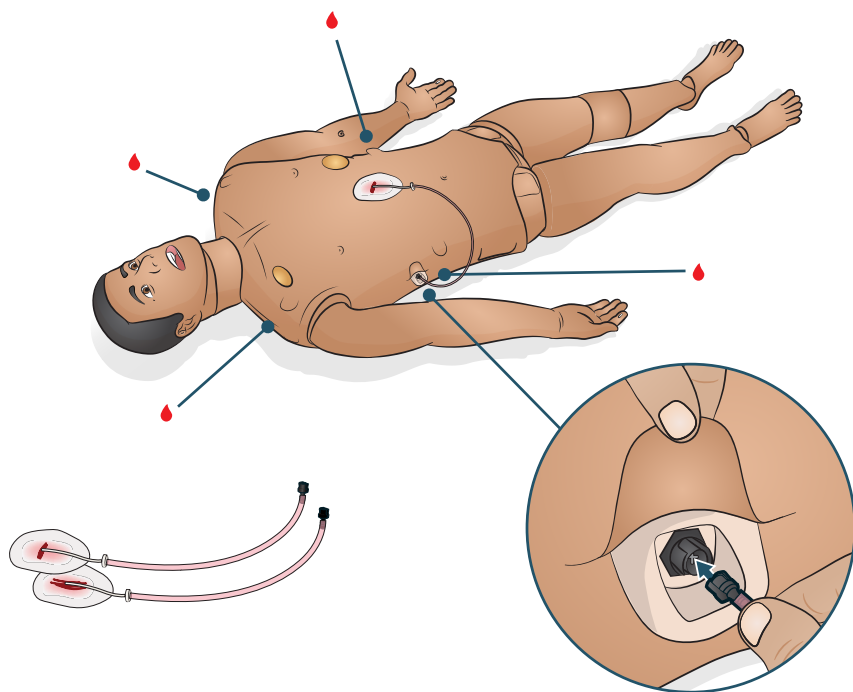

1. Ensure that the area where the wound is to be applied is clean and dry.
2. Apply the wounds with double-sided tape provided.
3. Connect the tube from the wound to the desired port.

Removing the wound

1. Follow the cleaning procedure in [Emptying the Blood System \(p. 87\)](#) with the wounds still attached.

2. Remove wounds kit once cleaning is complete.
3. Clean any tape residue left on the Patient Simulator skin with Laerdal Manikin Wipes.

**NOTE**

When removing wound tubing from the blood ports, cover the Patient Simulator skin with a cloth to prevent staining.

Prepare genitalia and catheterization

SimMan CC is fitted with neutral genitalia. It can be replaced with the supplied male or female genitalia to simulate catheterization.

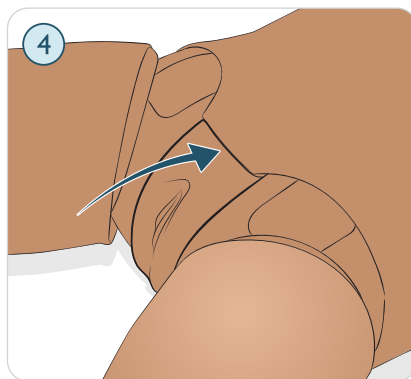
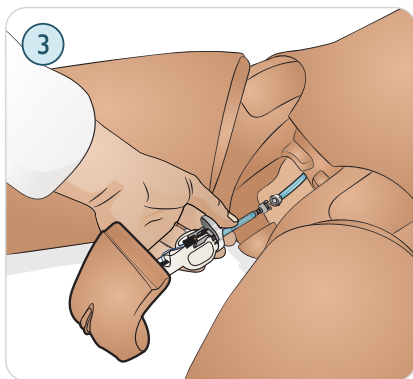
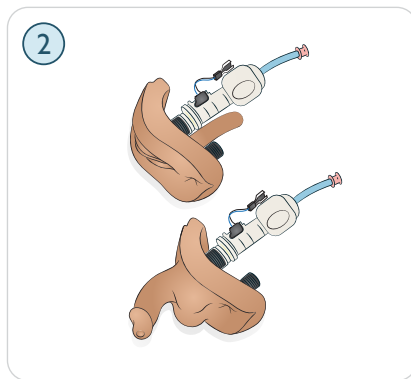
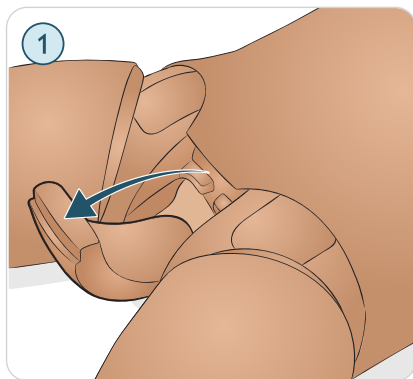

1. Remove the Patient Simulator's genitalia pad by gripping the pad pulling forward and down.
2. Select new genitalia module.
3. Connect the new genitalia module's urine tube and the catheterization sensor cable from inside the Patient Simulator pelvis to the urine bladder module.
4. Place the new genitalia module back into the Patient Simulator's pelvis.



NOTES

- *The Patient Simulator legs do not need to be removed before the genitalia pad can be replaced.*
- *Common skin preparations such as chlorhexidine and povidone iodine-based products may be used safely without staining the genitalia.*
- *Always use a water-based lubricant liberally when inserting a urine catheter.*

Use the following catheter sizes	
Female genitalia	Foley 14Fr and Lofric 16Fr
Male genitalia	Foley 16Fr and Lofric 16Fr

Head, Neck and Airway

Insert the head skin

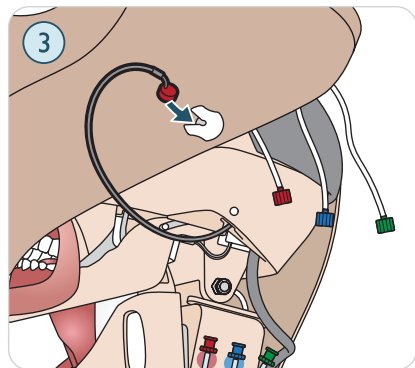
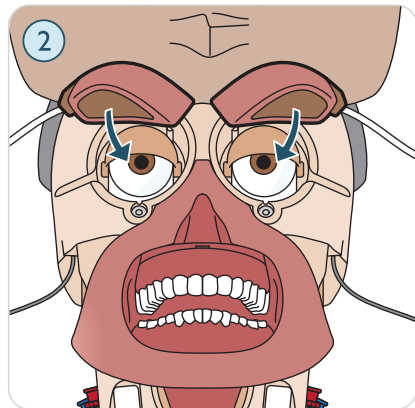
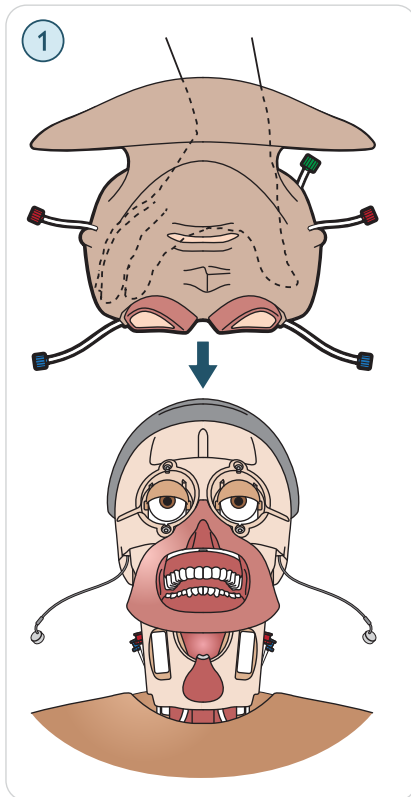

1. Position the head skin over the head module
2. Align the eye sockets over the eyes.
3. Align the airway tube with the right nostril, and secure into place.

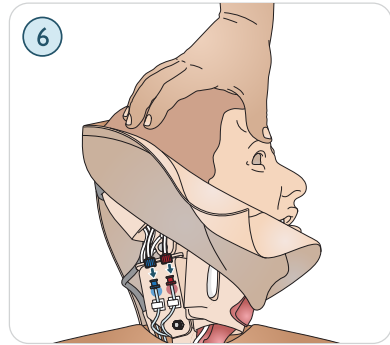
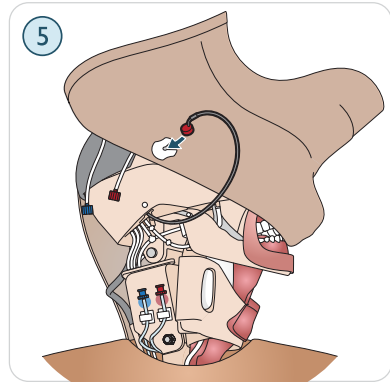
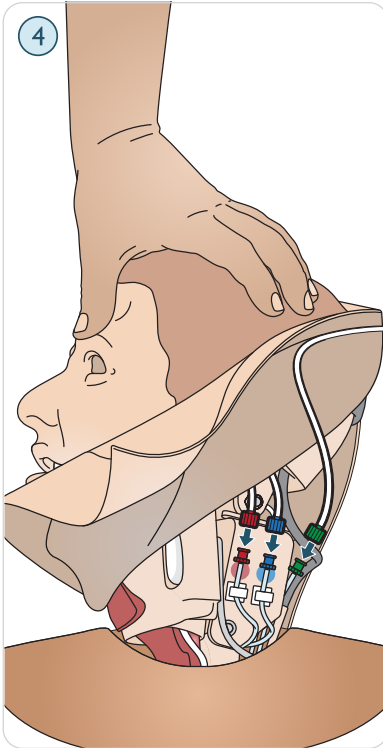

4. Insert the microphone carefully and connect the red, blue and green tube connectors.
5. Turn the head to the other side and insert the microphone.
6. Connect the red and blue tube connectors.

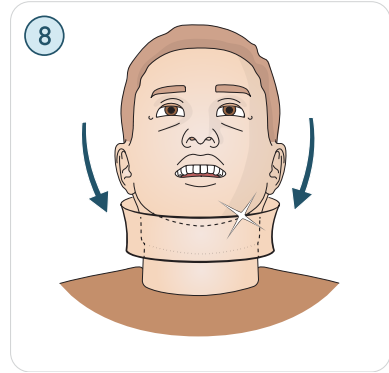
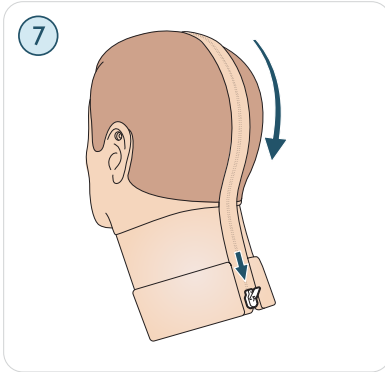

7. Close the zipper.
8. Place the neck skin.

Replacing the teeth

Soft upper teeth can be replaced with a hard set for enhanced realism while practicing intubations.

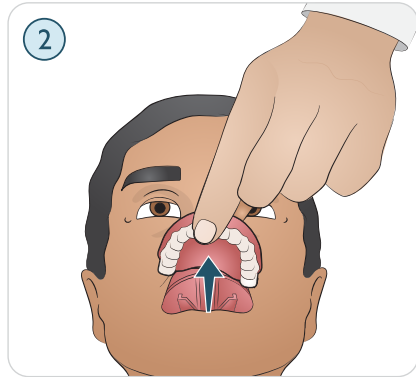
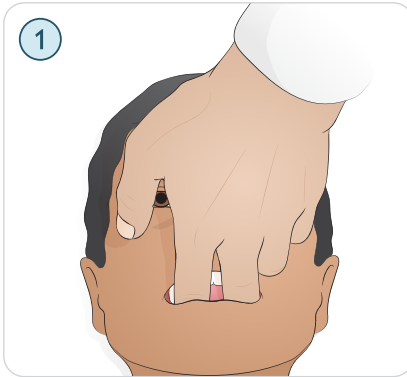

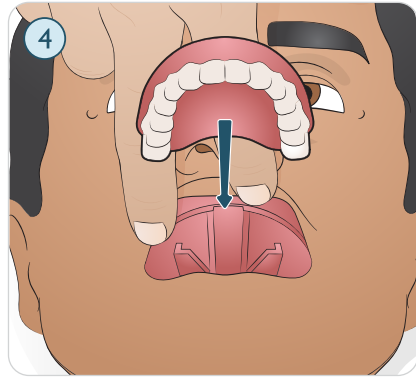
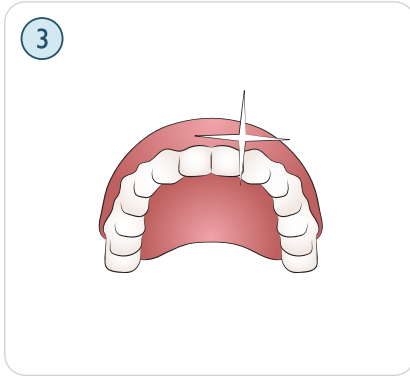

1. Grip the soft teeth with two fingers.
2. Remove the soft upper teeth.
3. Select the new teeth.
4. Align the new teeth with the gums and push back until the teeth engage and lock onto the gums.

Airway intubation

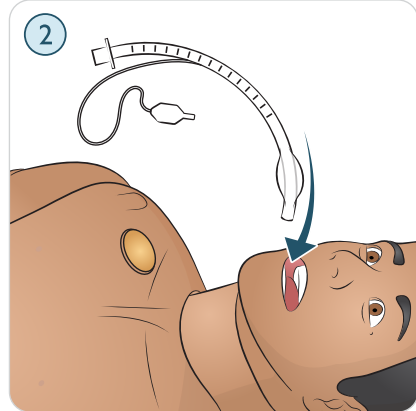
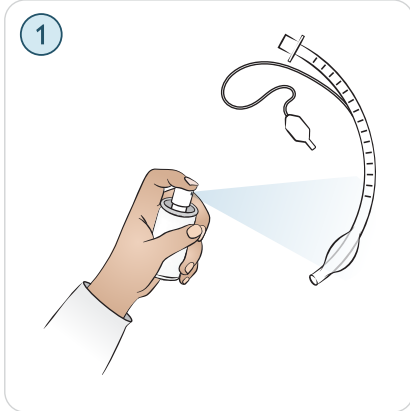

1. Lubricate the airway device.
2. Insert the lubricated device into the airway.



CAUTION

Do not spray lubricant directly into the airway.



NOTE

The use of smaller tube-type devices reduces wear of the Patient Simulator's airways.

Prepare simulated blood & fluids

Preparing simulated blood

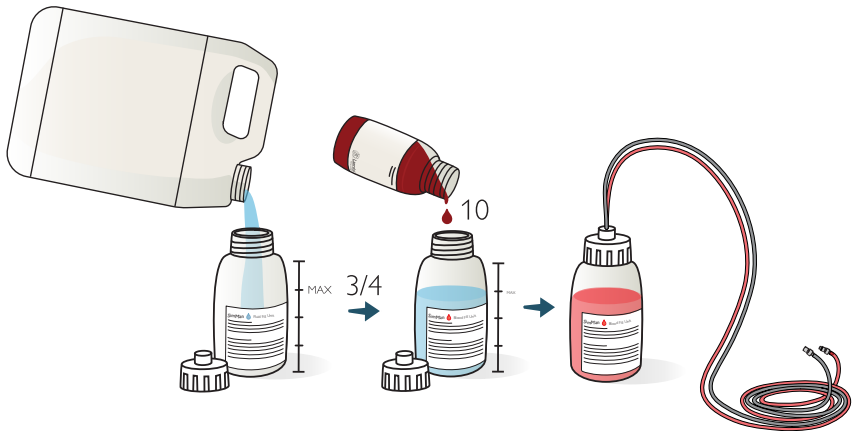

1. Fill blood bottle with approximately 500 ml distilled water.
2. Add approximately 10 drops of Laerdal Blood colored concentrate.
3. Tighten the cap and mix.

Preparing clear fluids and secretions

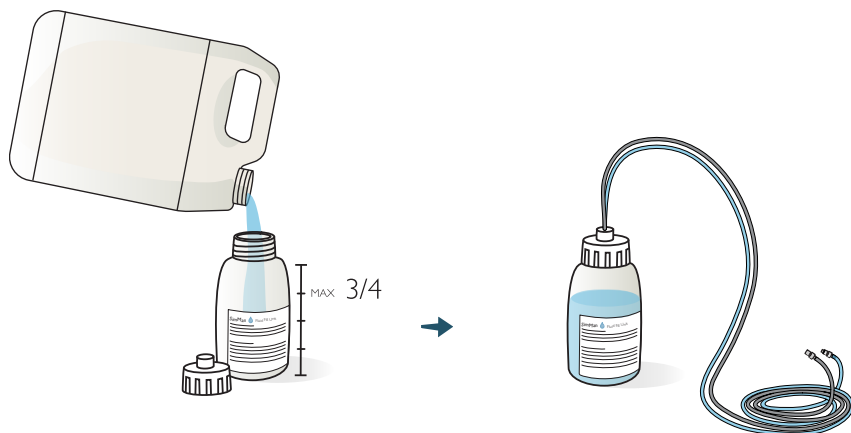

1. Fill fluid fill bottle with approximately 500 ml distilled water.
2. Tighten the cap.

Blood and fluid systems

The Patient Simulator has two internal tanks, one for simulated blood and one for fluids. The fluid fill panel is located at the top of the right leg.

 How-to video: [Bleeding Patient - Blood Flow Adjustment](#) in LLEAP.

Filling the blood internal tank

Ensure the patient simulator power is on.

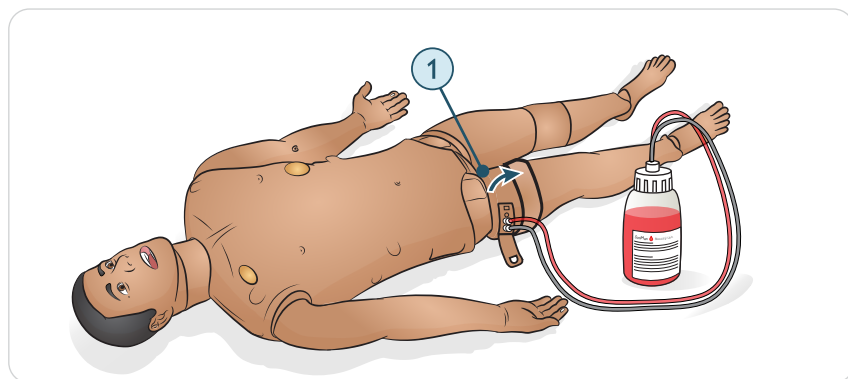

1. Roll the right leg skin down to expose the fill panel. Lift the panel cover.

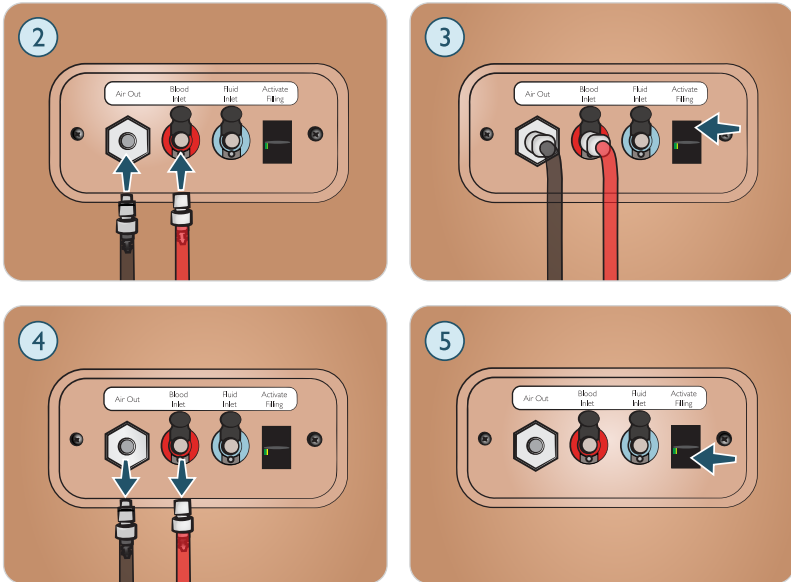

2. Connect the blood fill bottle tubes to the relevant inlet and the air outlet in the right leg panel.
3. Turn on the Activate Filling. The button will light up and blood will flow into the Patient Simulator.
4. When the flow stops, disconnect the fill bottle.
5. Turn off the Activate Filling.



NOTES

- Disconnect tubes from the Patient Simulator before turning off the Activate Fill button. Turning the fill button off before disconnecting the tubes will initiate draining of the tank.
- Only one tank can be filled at a time.

Filling the fluids internal tank

Ensure the patient simulator power is on.

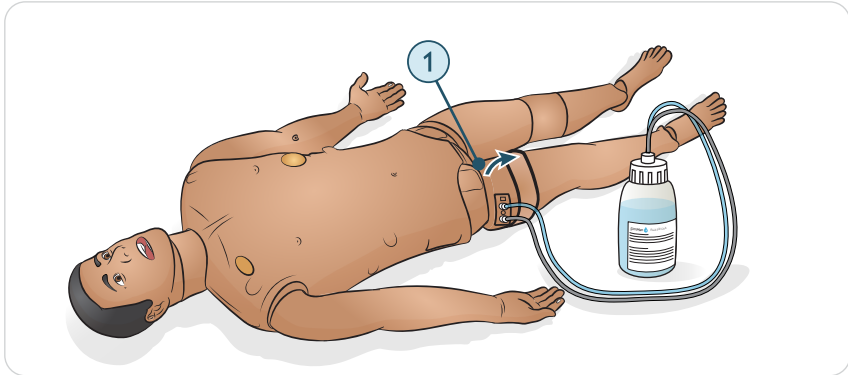

1. Roll the right leg skin down to expose the fill panel. Lift the panel cover.

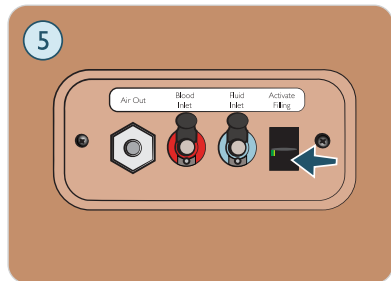
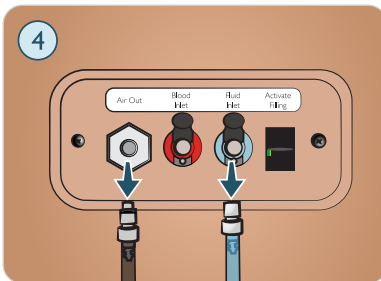
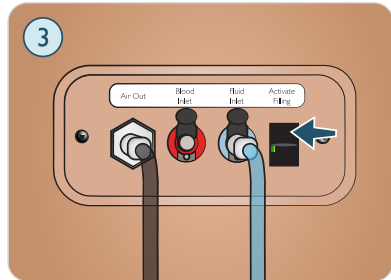
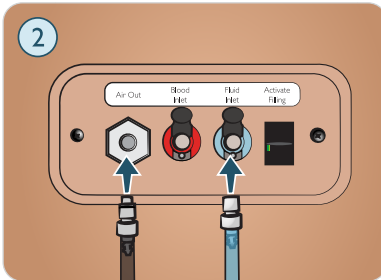

2. Connect the fluid fill bottle tubes to the relevant inlet and the air outlet in the right leg panel.
3. Turn on the Activate Filling. The button will light up and fluid will flow into the Patient Simulator.
4. When the flow stops, disconnect the fill bottle.
5. Turn off the Activate Filling.



NOTES

- *Disconnect tubes from the Patient Simulator before turning off the Activate Fill button. Turning the fill button off before disconnecting the tubes will initiate draining of the tank.*
- *Only one tank can be filled at a time.*

Secretions, sweat and urine

Sweat, tears, cerebrospinal fluid (CSF) and urine functions can be set and adjusted in the LLEAP Fluids tab.

How-to video: [Urine Function](#) in LLEAP.

How-to video: [Show Opening Fluids Tab](#) in LLEAP.

Leg

Preparing the tibial IO with blood

1. Attach an IV bag to the tibial tube.
2. Close off the pinch clamp.
3. Roll down leg skin to access the tibial IO module.
4. Remove the IO tape.
5. Lift out the module from the leg.
6. Remove the tube from the module.

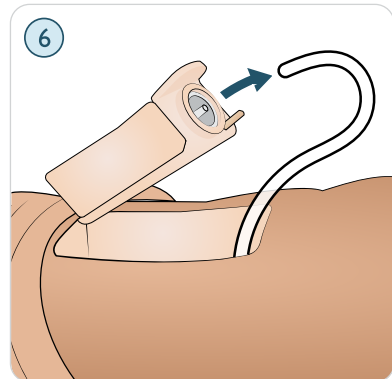
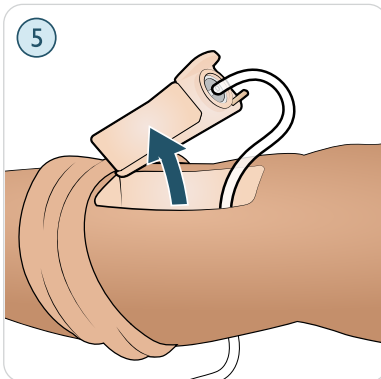
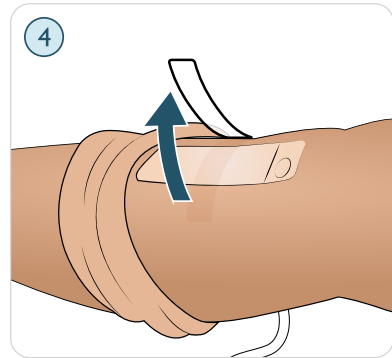
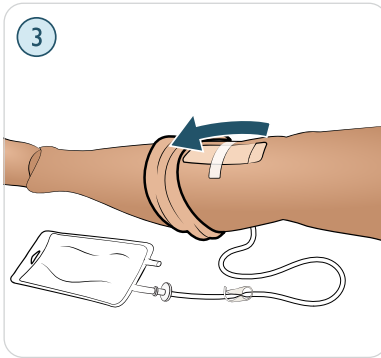
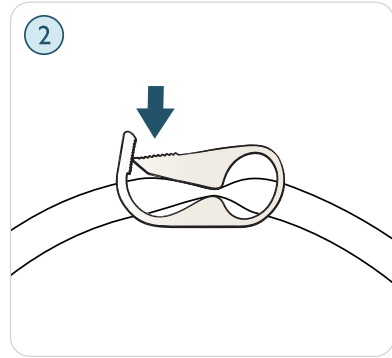
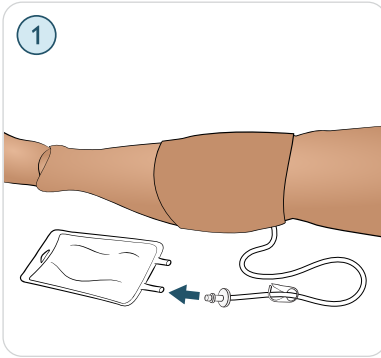

7. Fill the module with 30-35 ml of simulated blood.
8. Connect the tube to the module and insert it into the leg. Feed the drain tube out of the back of the leg to ensure that there are no kinks.

9. Secure with tape.
10. Roll up the leg skin.

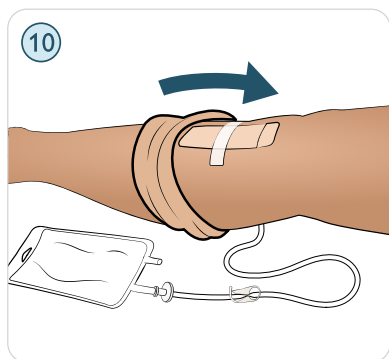
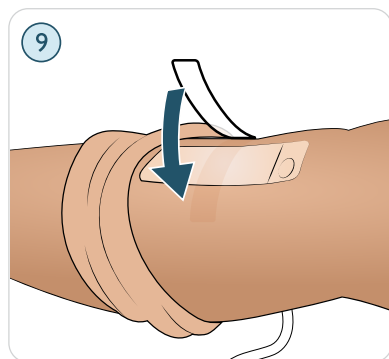
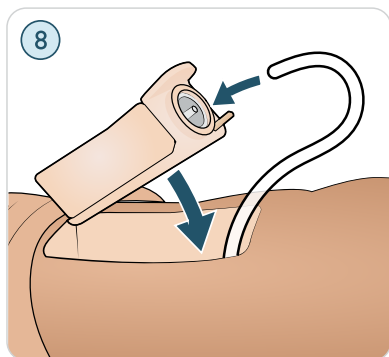
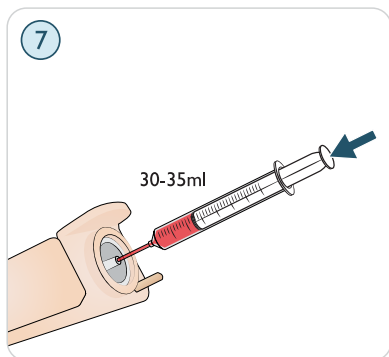

Recommended device sizes	
BIG Automatic Intraosseous Device	15 G
EZ-IO, 15 G x 1"	1.8 x 25 mm
Jamshidi ® Illinois Bone Marrow Aspiration/Intraosseous Infusion Needle	18 G 9/16" (14 mm) - 1 1/2" (38 mm)

**CAUTION**

Do not inject fluids into these pads unless approved IO modules with fluid outlets are in place.

Prepare Trauma leg

Lay the Patient Simulator on a flat surface.

MAINTENANCE

Torso

Open the torso skin

Some maintenance tasks can only be carried out by opening the torso skin.

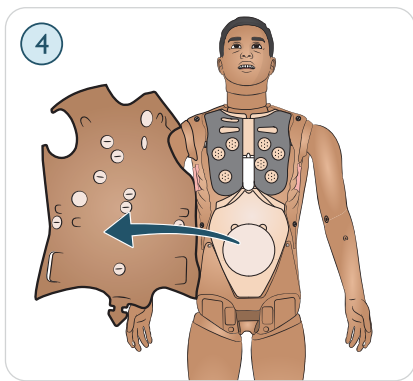
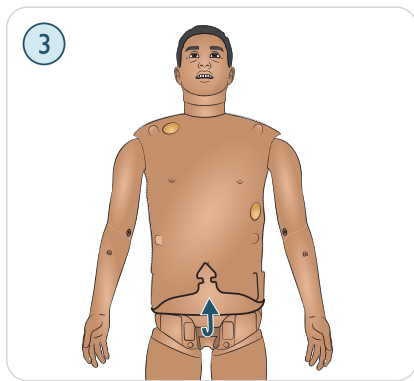
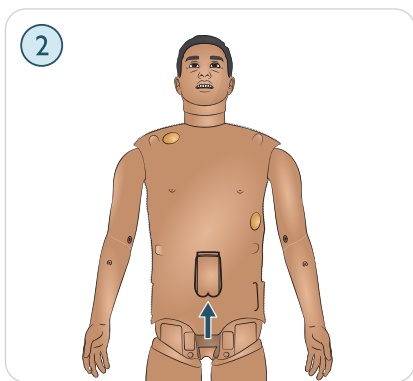
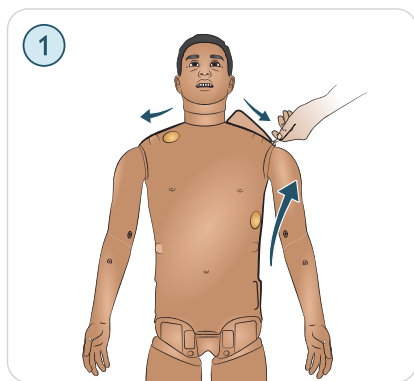

1. Unzip the skin at shoulders and torso.
2. Remove the genitalia pad.
3. Release the skin flap.
4. Move the torso skin to the side.

**NOTE**

Ensure that the tubes and cables are connected to the stomach foam.

Replace the pneumothorax bladders

Replace the pneumothorax bladders after multiple decompressions.

Before starting, follow the [Open the torso skin \(p. 59\)](#) procedure.

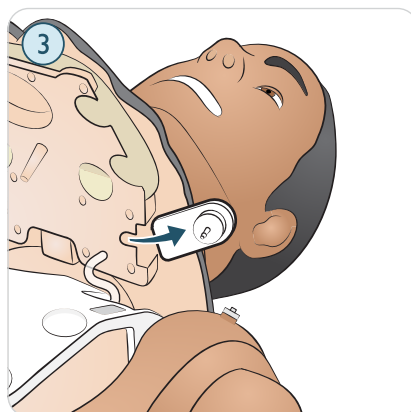
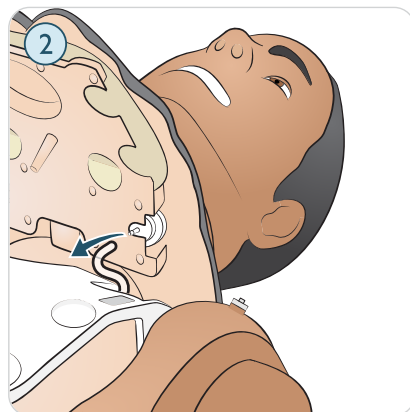
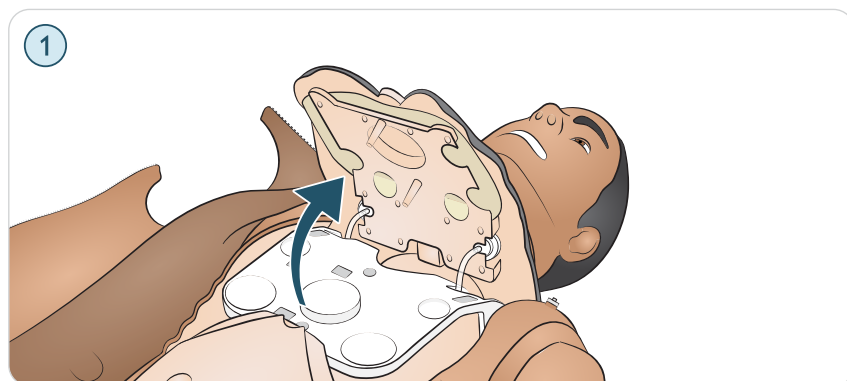

1. Lift the chest plate to expose pneumothorax bladders.
2. Slide the bladder(s) out.
3. Disconnect the tube(s).



4. Discard used bladder(s).
5. Select new bladder.

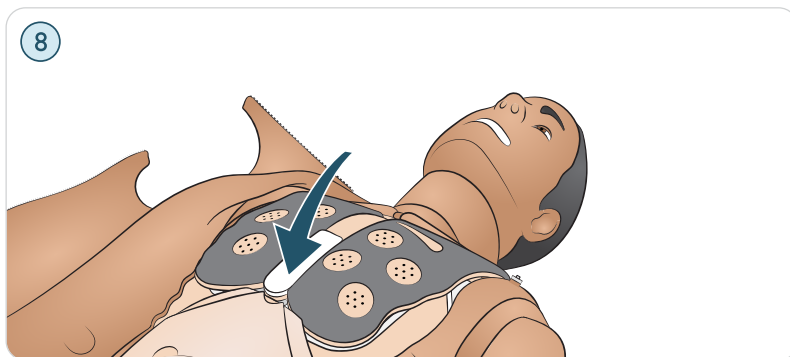
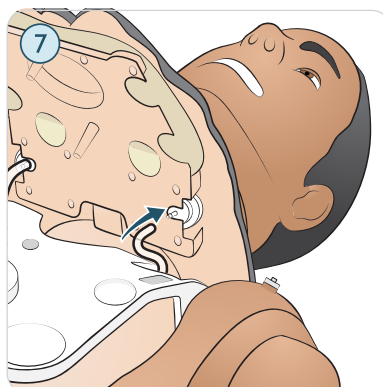
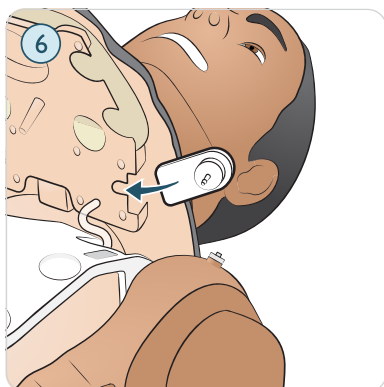

6. Slide bladder into place.
7. Reconnect tube to the bladder.
8. Replace chest plate.

Replacing the chest rise bladders

Replace the chest rise bladders if they leak or are damaged.

Before starting, follow the [Open the torso skin \(p. 59\)](#) procedure.

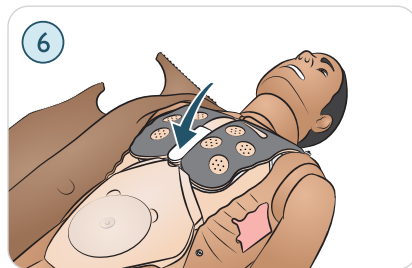
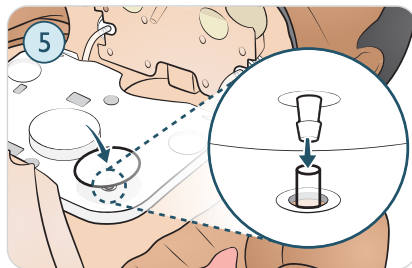
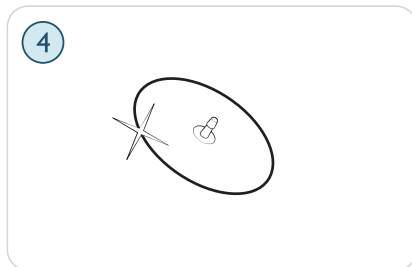
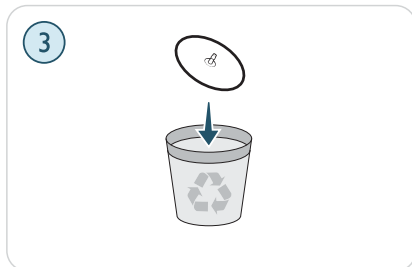
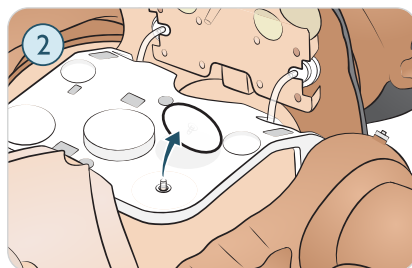
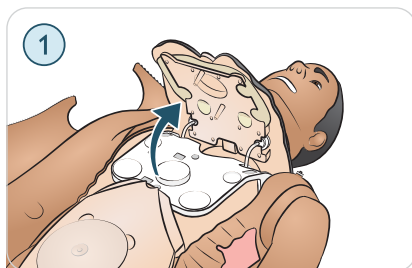

1. Lift the chest plate to expose the chest rise bladders (one on each side).
2. Disconnect the tube(s).
3. Discard used bladder(s).
4. Select new bladder(s).
5. Insert bladder(s) and reconnect tube(s).
6. Replace chest plate.

Replace the chest drain pleura

Before starting, follow the [Open the torso skin \(p. 59\)](#) procedure.

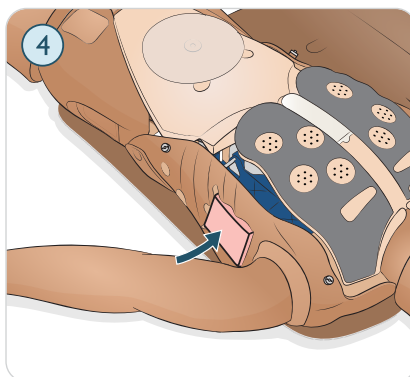
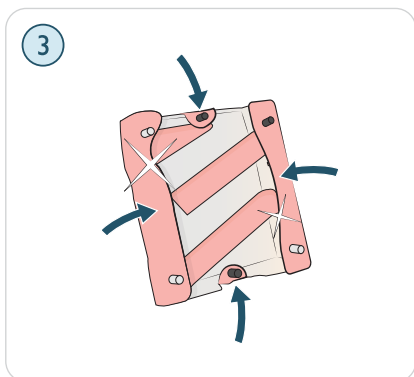
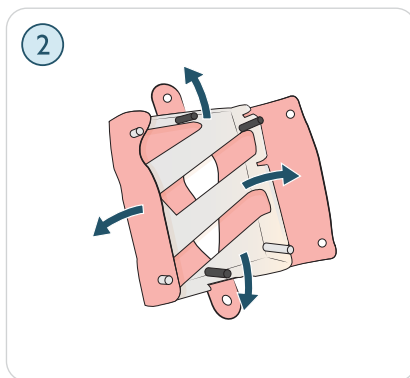
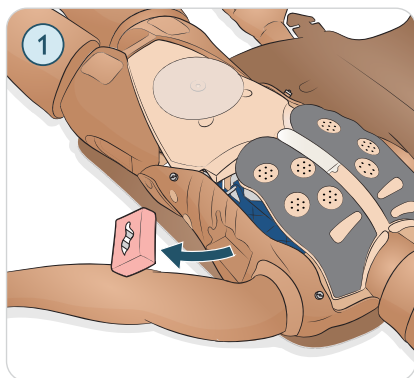

1. Remove the used chest drain pleura module.
2. Remove and discard the pleura skin from the module.
3. Replace the used pleura skin with a new one.
4. Insert the module into the torso.

Replace the blood system filter

Replace the filter if it becomes clogged and reduces blood flow.

Ensure the Patient Simulator is turned off.

[Open the torso skin \(p. 59\)](#)

1. Disconnect the filter from the leg and pelvis blood tubes by unscrewing the black connectors at each end.
2. Remove filter from the Patient Simulator.
3. Discard clogged filter.
4. Select a new filter.
5. Connect a new filter by reversing the steps above.



CAUTION

Do not run the Patient Simulator without a filter.

Replacing the torso skin

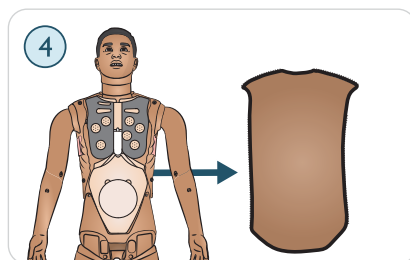
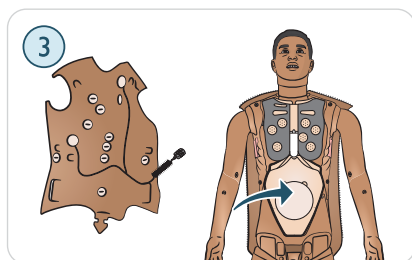
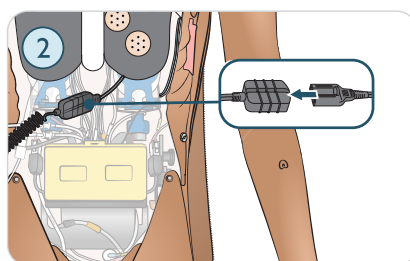
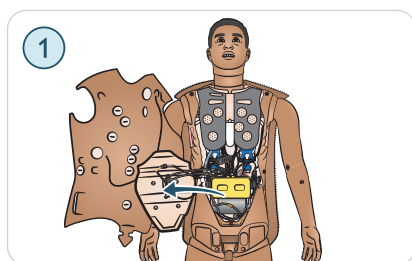

1. Move the stomach foam carefully to one side to avoid pulling on connecting tubes and cables.
2. Disconnect the torso skin cable from the Patient Simulator.
3. Remove the front torso skin section and replace the stomach foam.
4. Remove the back torso skin section.

Close the torso skin

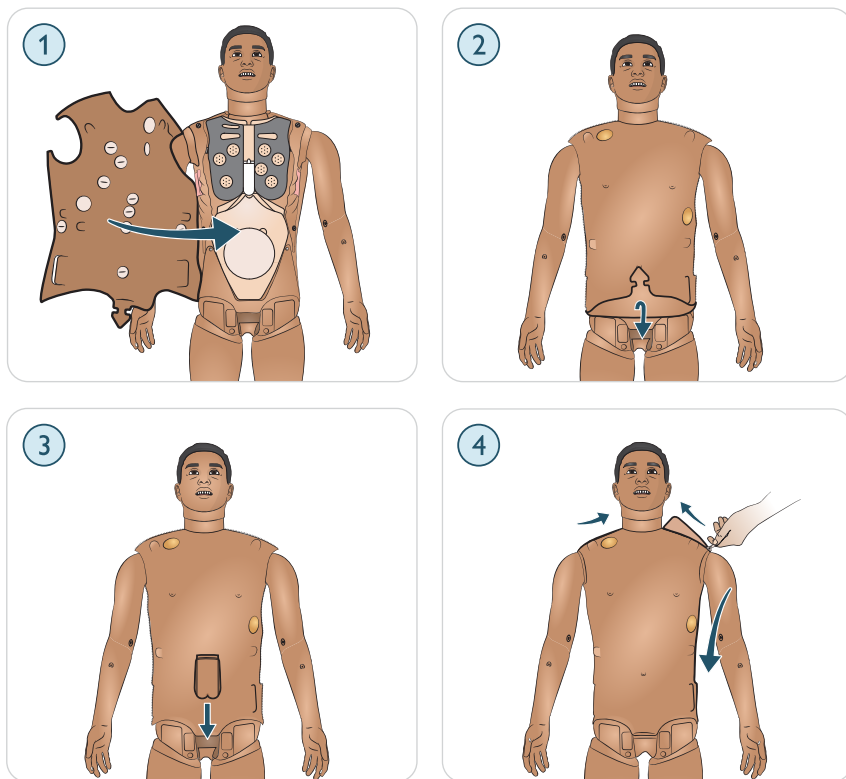

1. Put the torso skin over the torso.
2. Push down the skin flap over the genitalia area.
3. Attach the genitalia pad.
4. Zip the torso at the shoulders and torso.

Arm

Replacing IV Arm Catheter/Filter

Replace the IV catheter module if it is damaged or if resistance is unrealistically high when injecting fluids.

1. Unzip and fold down the IV arm skin to expose the IV catheter module.

- Using the no. 4 Phillips screwdriver; remove the 4 screws and pull the IV module out of the arm.

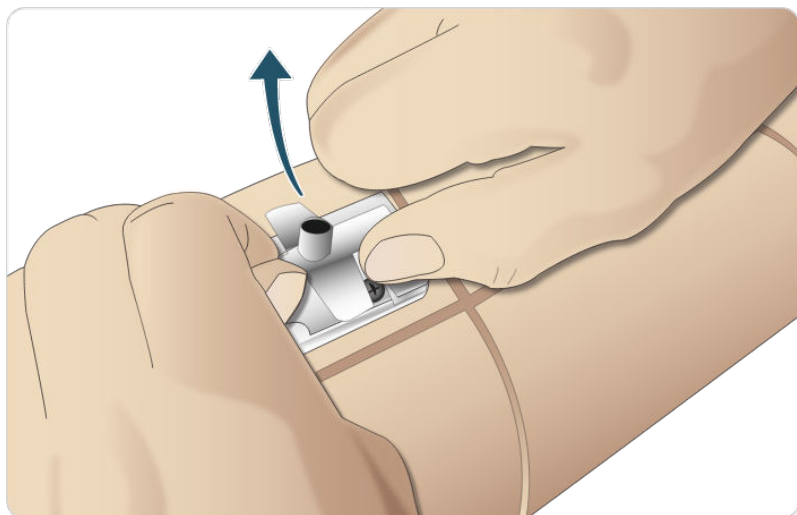

- Lift the IV catheter up and out, exposing the recess where the filter is located.

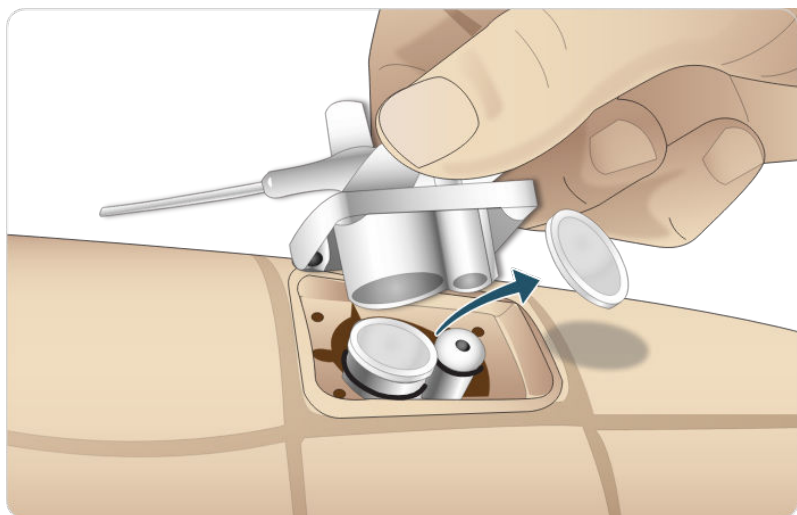

- Lift out the IV filter and replace with a new filter.

Remove the arm

Before starting, follow the [Open the torso skin \(p. 59\)](#) procedure.

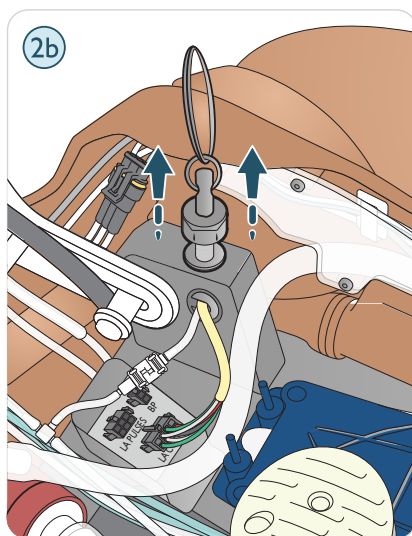
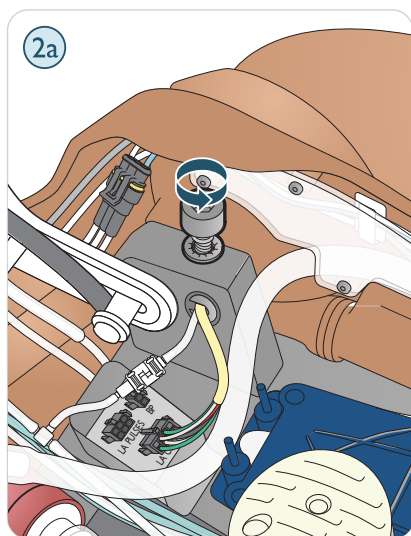
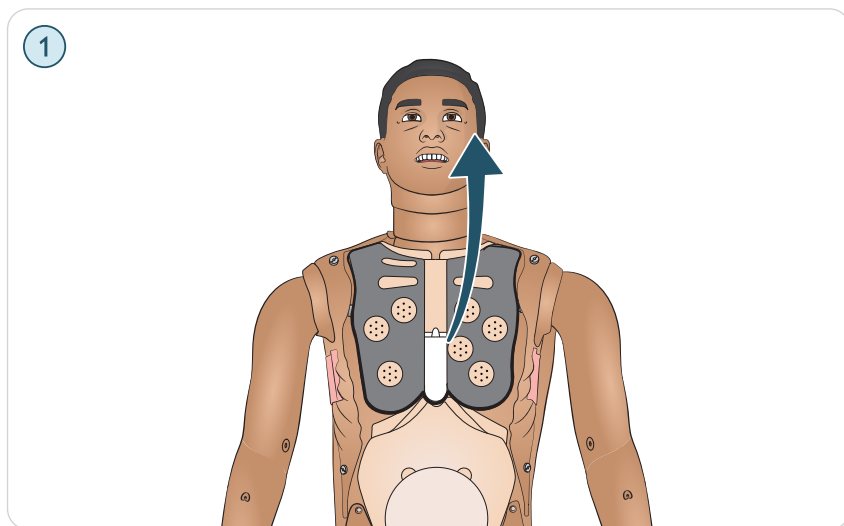

1. Lift the chest plate to expose the arm bolt.

2.
 - a. Unscrew the arm bolt. Do not unscrew fully
 - b. Lift up the arm bolt.

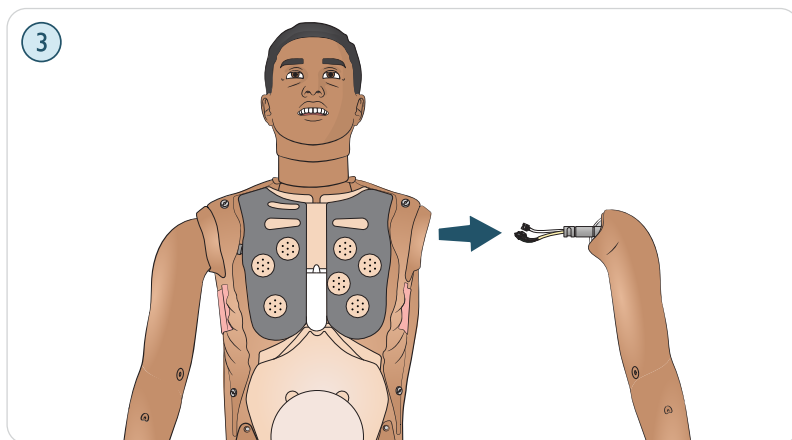

3. Remove the arm.

Replace the arm

- Take the new arm.

 How-to video: [How to Replace Arms.](#)

Attaching the left arm

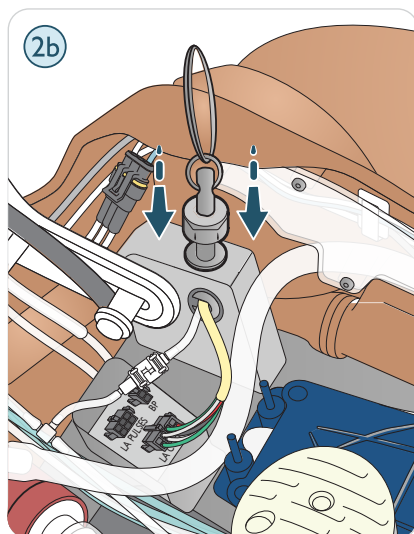
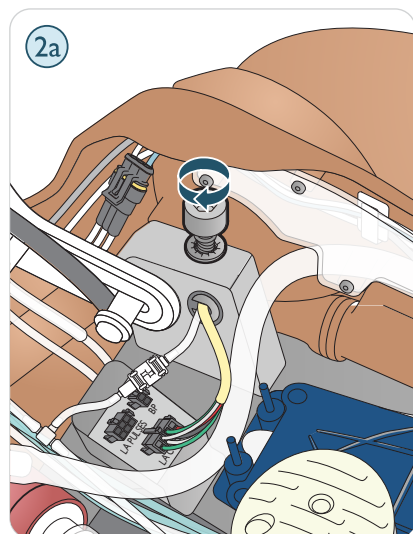
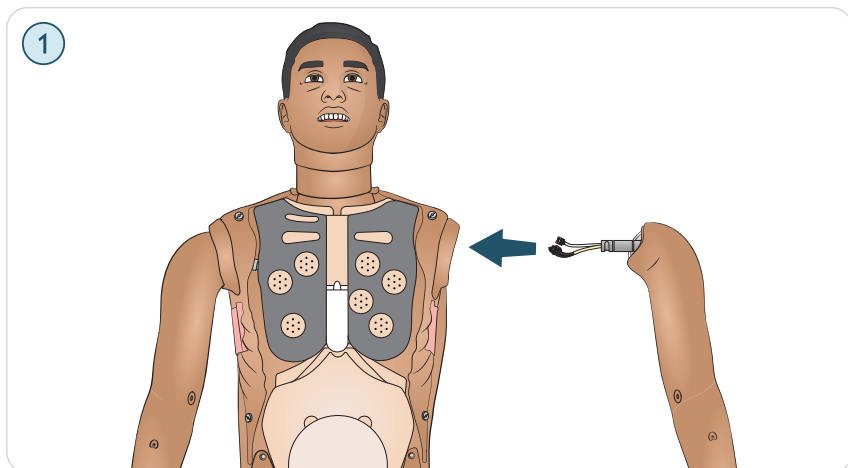

1. Insert the arm in its socket
2. a. Screw the arm bolt.
b. Push down on the arm bolt.

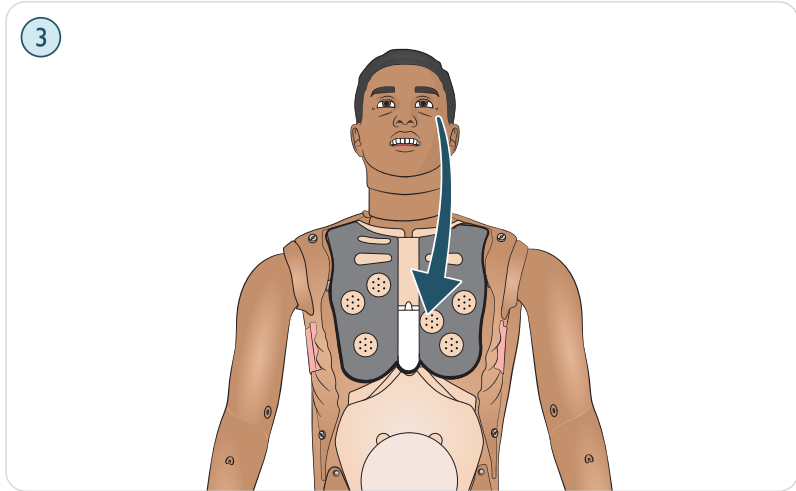

3. Close the chest plate

Head, Neck and Airway

Replacing cricothyroid tape and neck skin

After creating an emergency airway through the cricothyroid membrane, replace the perforated tape before starting a new simulation session.

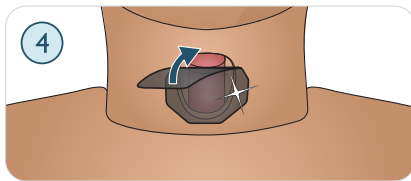
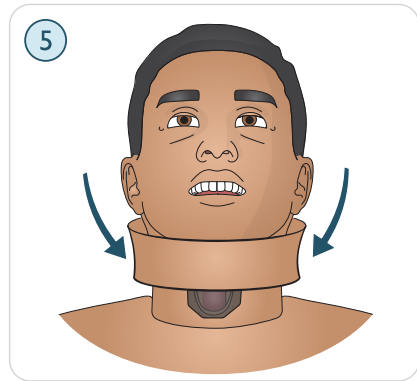
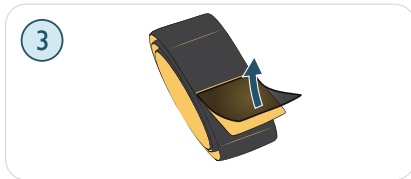
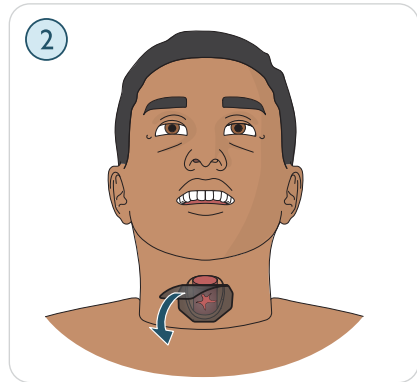
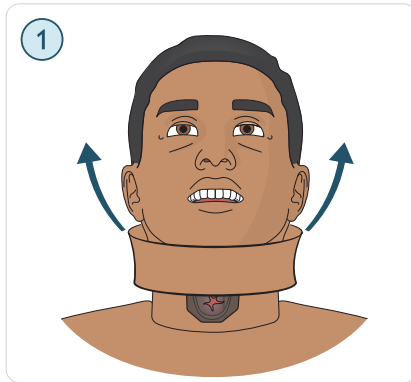

1. Remove the neck skin.
2. Remove damaged or perforated tape.
3. Select a new section of cricothyroid tape.
4. Replace with new tape, ensuring it completely covers and seals the opening to prevent leakage during ventilation.
5. Replace the neck skin.



NOTE

If the used neck skin is in good condition, move the skin along to position a new section over the cricothyroid tape. If the used neck skin is in good condition, move the skin along to position a new section over the cricothyroid tape.

Remove Head Skin

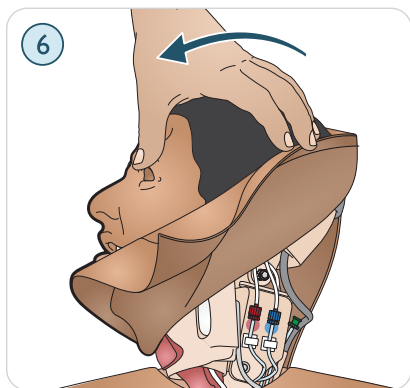
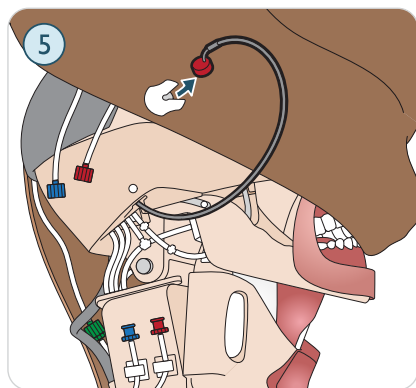
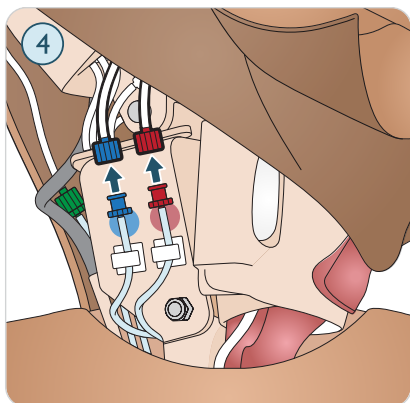
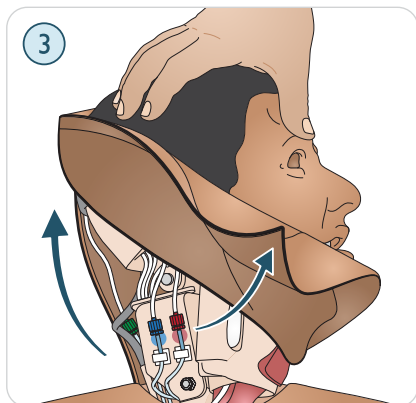
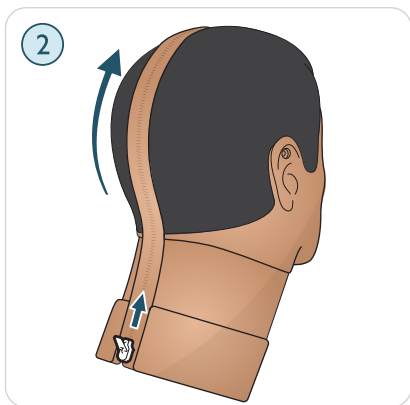
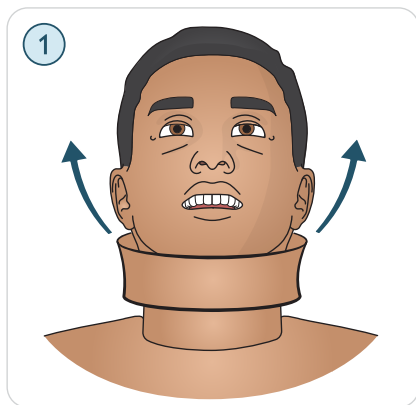

1. Remove the neck skin.
2. Unzip the head skin.
3. Lift the head skin to expose tubing.
4. Disconnect the blue and red tube connectors.
5. Carefully remove the microphone cable from inside the head skin.
6. Turn the head.

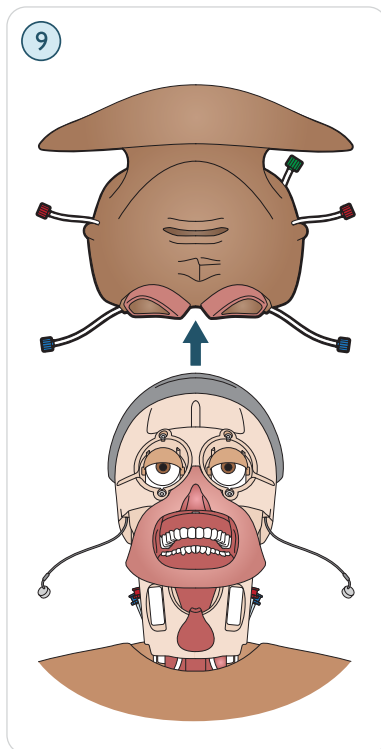
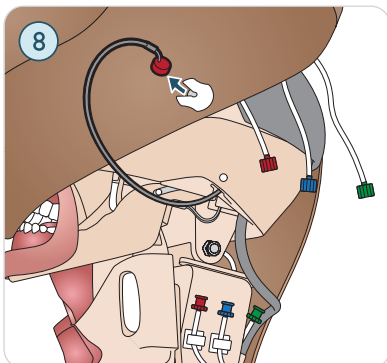
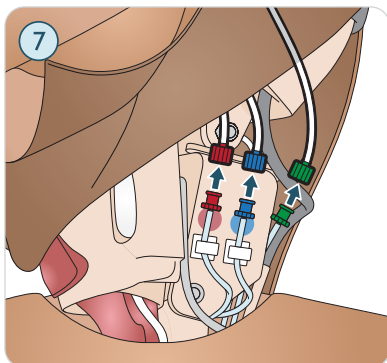

7. Disconnect the red, blue and green tube connectors.
8. Carefully remove the microphone cable from inside the head skin.
9. Remove the head skin completely.

Replace the head skin

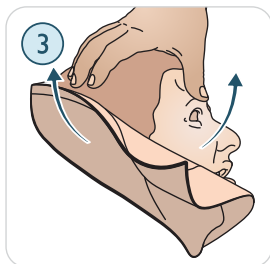
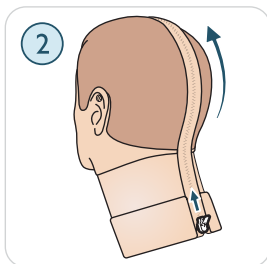
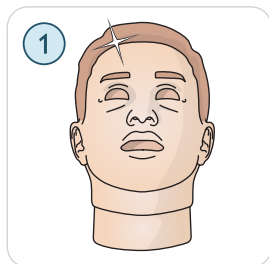

1. Select the new head skin.
2. Unzip the head skin.
3. Turn the head skin inside out.

Insert the head skin

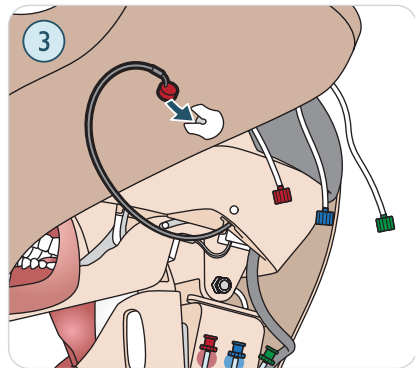
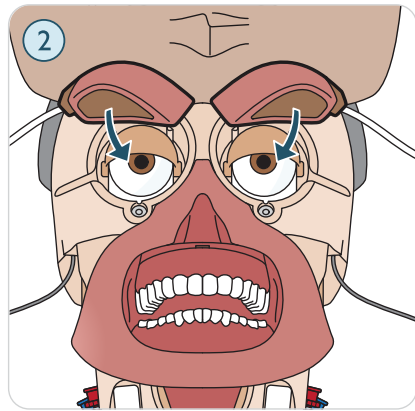
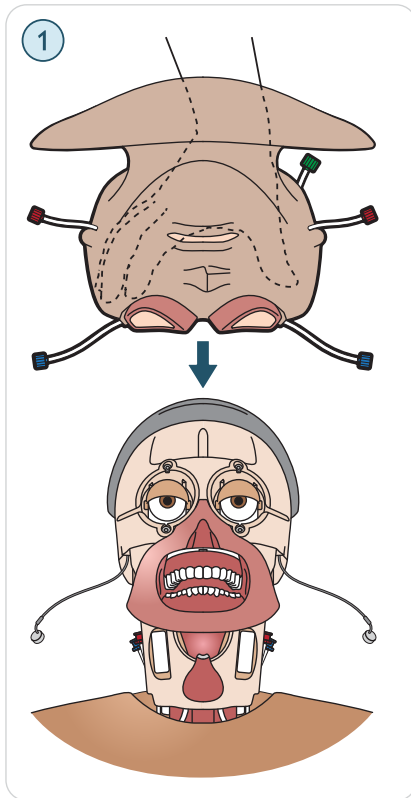

1. Position the head skin over the head module
2. Align the eye sockets over the eyes.
3. Align the airway tube with the right nostril, and secure into place.

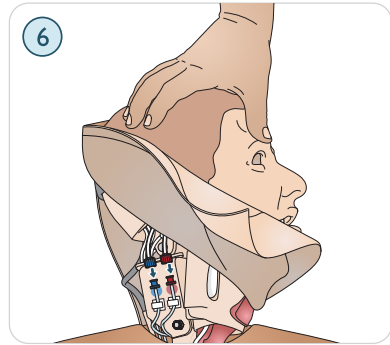
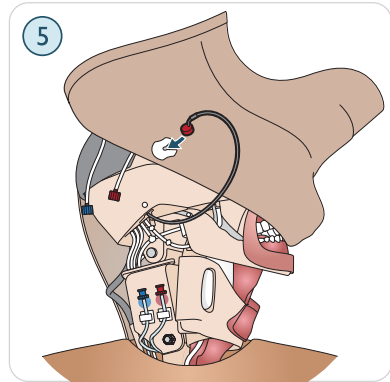
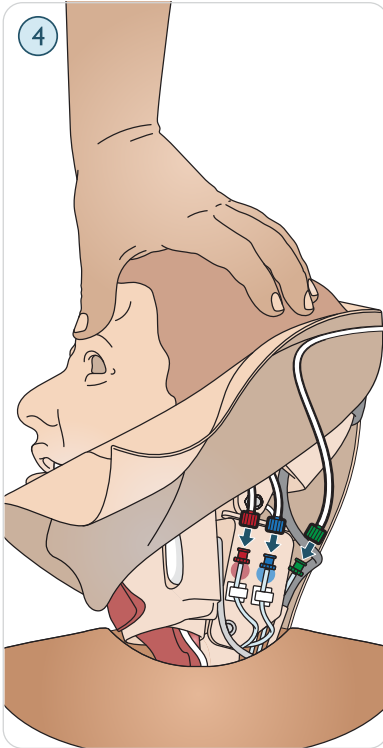

4. Insert the microphone carefully and connect the red, blue and green tube connectors.
5. Turn the head to the other side and insert the microphone.
6. Connect the red and blue tube connectors.

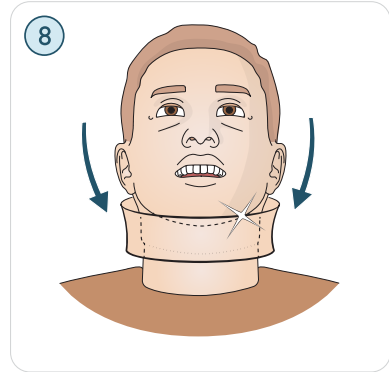
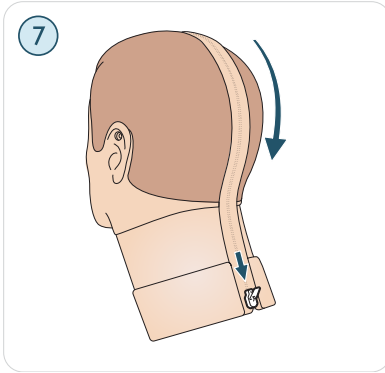

7. Close the zipper.
8. Place the neck skin.

Leg

Removing the left leg

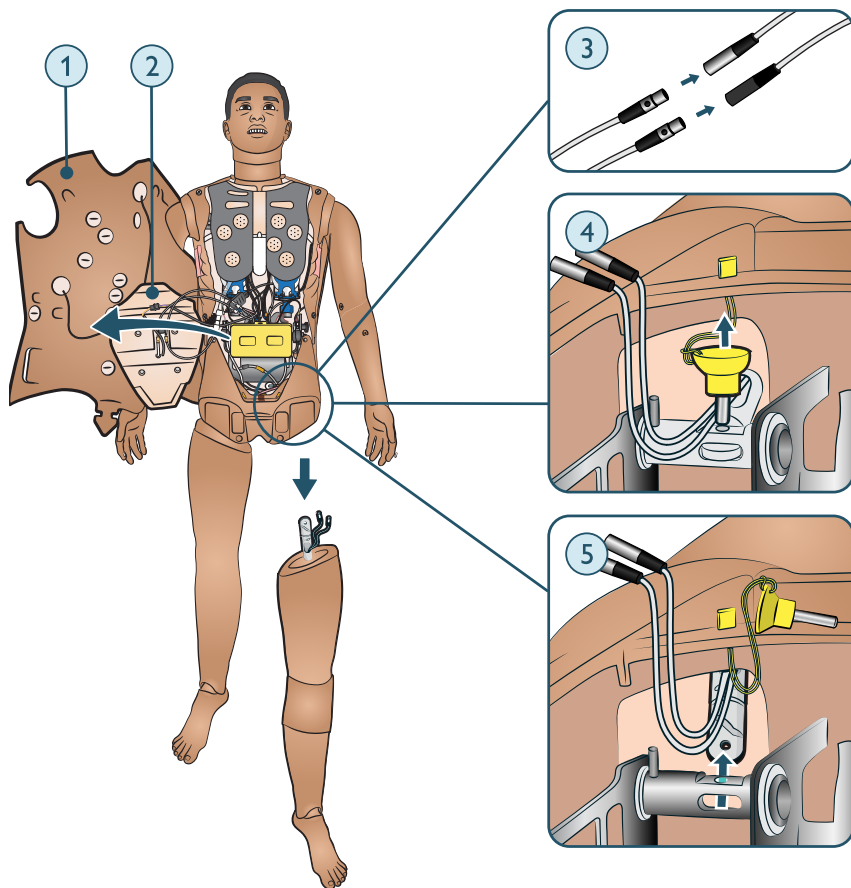

1. Before starting, follow the [Open the torso skin \(p. 59\)](#) procedure.
2. Move stomach foam to one side.
3. Disconnect the cables to the left leg.
4. Pull out the thumb lock pin.
5. Carefully remove the leg.

Replacing tibial IO

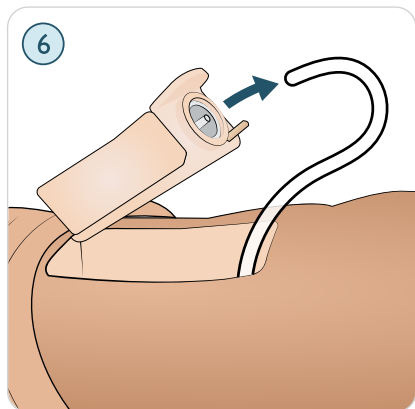
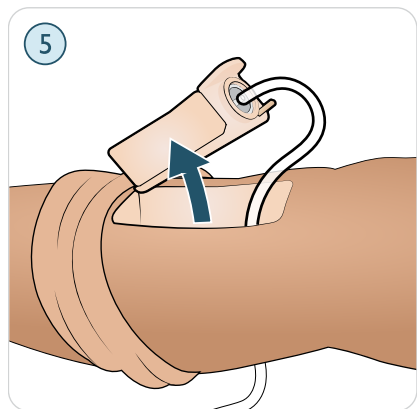
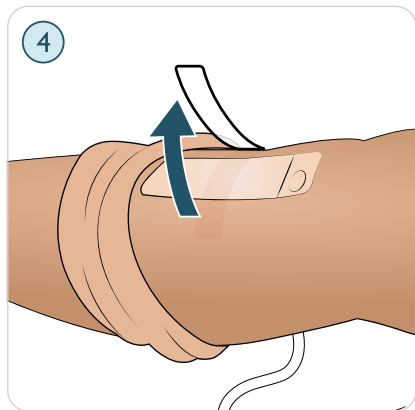
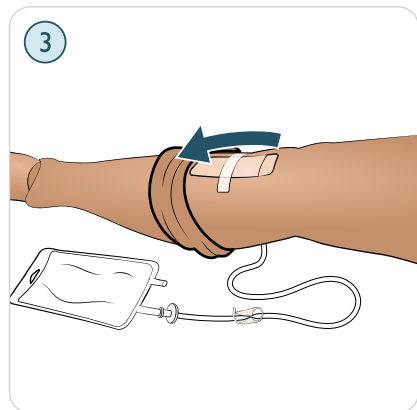
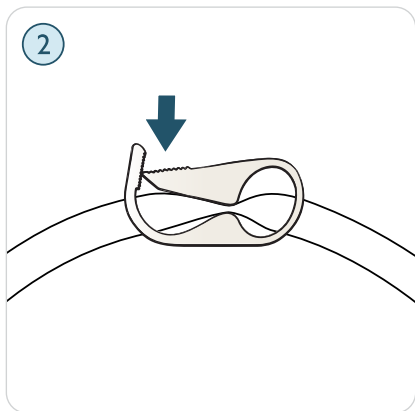
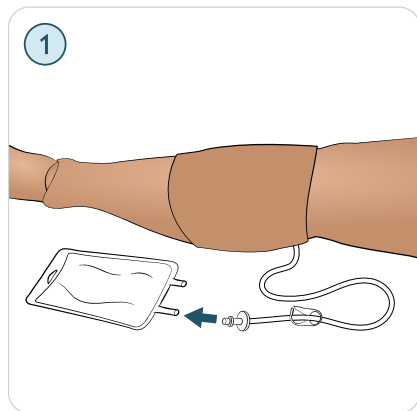

1. Attach the tibial IO drain bag to the tibial tube.
2. Close off the pinch clamp.
3. Roll down leg skin to access the tibial IO module.
4. Remove the IO tape.
5. Lift out the tibial IO unit from the leg.
6. Remove the tube from the tibial IO module.

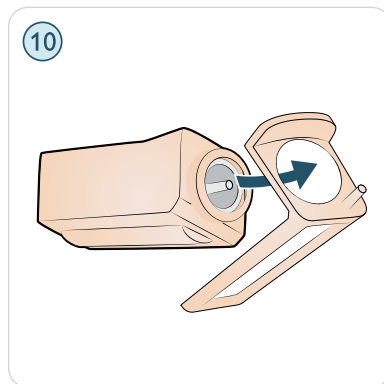
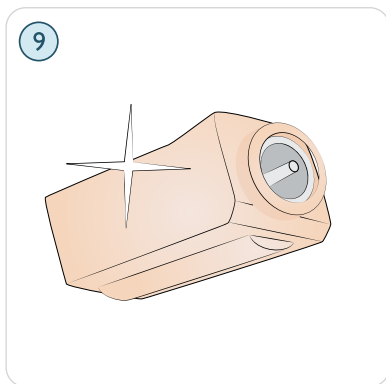
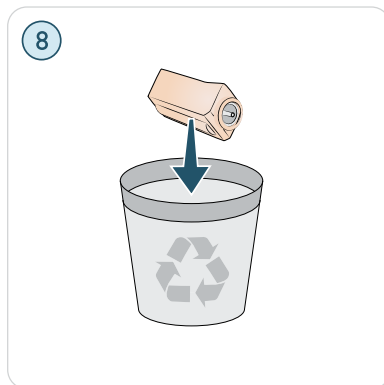
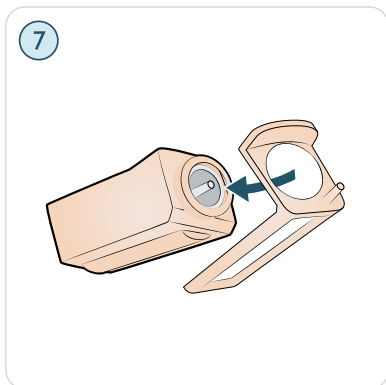

7. Remove the tibial IO pad from the tibial IO chassis.
8. Discard used tibial IO pad.
9. Ensure the nipple is retracted on the new tibial IO pad.
10. Secure the tibial IO pad into the chassis and press the base of the pad until the nipple moves forward and locks into place.

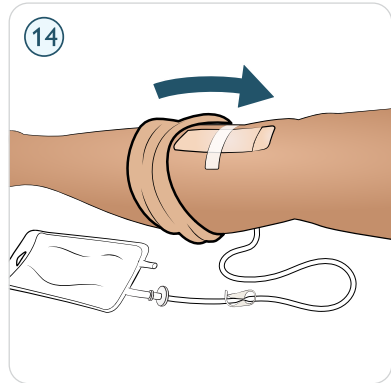
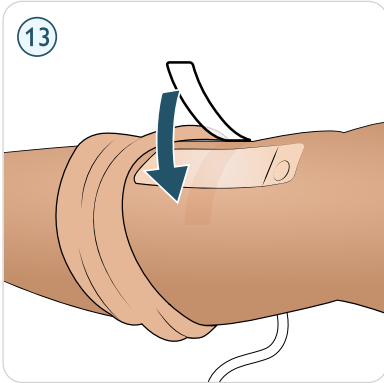
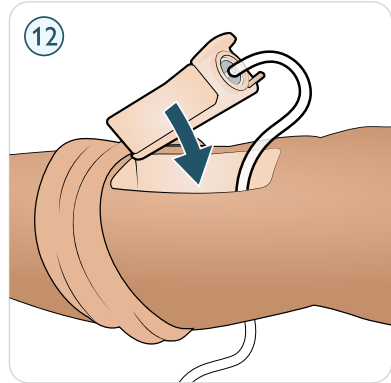
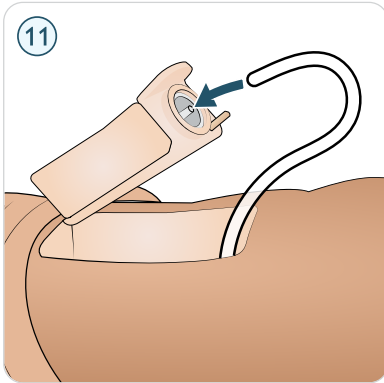

11. Connect the tibial tube to the tibial IO unit.
12. Insert the tibial IO module into the leg.
13. Secure the module with tape.
14. Roll the leg skin over the tibial module.

GENERAL CARE AND CLEANING

Regular care, cleaning and maintenance are required to ensure longevity of the Patient Simulator.

General patient simulator care

- Wash hands before use and place the Patient Simulator on a clean surface to maintain Patient Simulator skins.
- Wear gloves as required during simulation scenarios. Avoid using colored plastic gloves, as they may cause discoloration of the Patient Simulator skin.
- If a training session involves the use of fluids in the IM, IV and IO sites, drain the fluid immediately after the training session.
- Clean the exterior with water, water and mild soap, or 60% isopropanol as required. Avoid fluids containing over 70% ethanol which can cause damage to gaskets and sealing material.
- When not in use, cover the Patient Simulator and remove pillow from under head.
- Refer to the Maintenance section for further care and maintenance of specific components.



CAUTIONS

- *Unplug the device from communication lines, mains power outlet or any power source before cleaning.*
- *Do not use liquid cleaners or aerosol cleaners.*
- *Avoid using food-based products in reservoir bags or on simulator as this will promote mold growth and permanent stains.*
- *Do not use felt-tipped markers, ink pens, acetone, iodine or other staining medications near the Patient Simulator. Take care not to place the Patient Simulator on newsprint or colored paper. All staining may be permanent.*
- *Avoid 70% ethanol for cleaning fluids as it can cause failure over time with some of the gaskets.*

Cleaning after use

- Clean individual components following a training session where heavy usage occurs, or when liquids have been introduced into the system.

- Wipe the skin with a moist cloth to remove stains. Remove wet clothes or linens. Glue residue from the wound module tapes may be removed with a moist cloth.

IV Arm

Daily cleaning

When the day's sessions are done, flush the IV Arm with air to remove any fluid/liquid in the system. Connect a syringe filled with air to the IV catheter; and flush the IV Arm with air until only air exits the overflow tube.

Before storage or shipping

Flush the IV Arm system with Isopropanol 60%-70%, and then flush with air.

Regular cleaning of IV Arm

Regular cleaning of the IV arm system is recommended as part of proper care of the product. Once or twice a month, the IV Arm system should be cleaned thoroughly



NOTE

Do not use force if the IV fluid system seems blocked; it is likely that the simulator is not turned on.

1. Ensure that the simulator's power is ON, and that the IV Arm is properly connected.
2. Connect a syringe filled with Isopropanol 60%-70% to the IV catheter; and flush the IV Arm System with it.
3. Connect a syringe filled with air to the IV catheter; and flush the IV Arm until only air exits the overflow tube.



NOTE

Never store the simulator with isopropanol or liquid in the IV Arm System.

Cleaning monthly

It is recommended that the following components are cleaned once or twice a month:

- Arms
- Fluid system
- Blood system



NOTE

For additional maintenance information related to cleaning of the Arms, Blood and Fluid System, refer to the relevant Maintenance Section.

Clothing

For washing instructions refer to care labels.

Servicing

A full service of the Patient Simulator should be performed at regular intervals.

Always perform a service

- If liquids have been spilled in the Patient Simulator.
- After use in dusty environments.



NOTE

All servicing must be performed by qualified service personnel.

Preventative maintenance

Laerdal recommends the Preventative Maintenance (PM) Service. This service will help to maintain the product in optimal operating condition. Contact your local Laerdal representative for more information.

Cleaning the blood system

Once all sessions are complete, flush the Blood System with distilled water, with the wounds connected. This will remove remains of Laerdal blood in the Blood System, and prevent clogging of valves and tubing.

Emptying internal blood tank

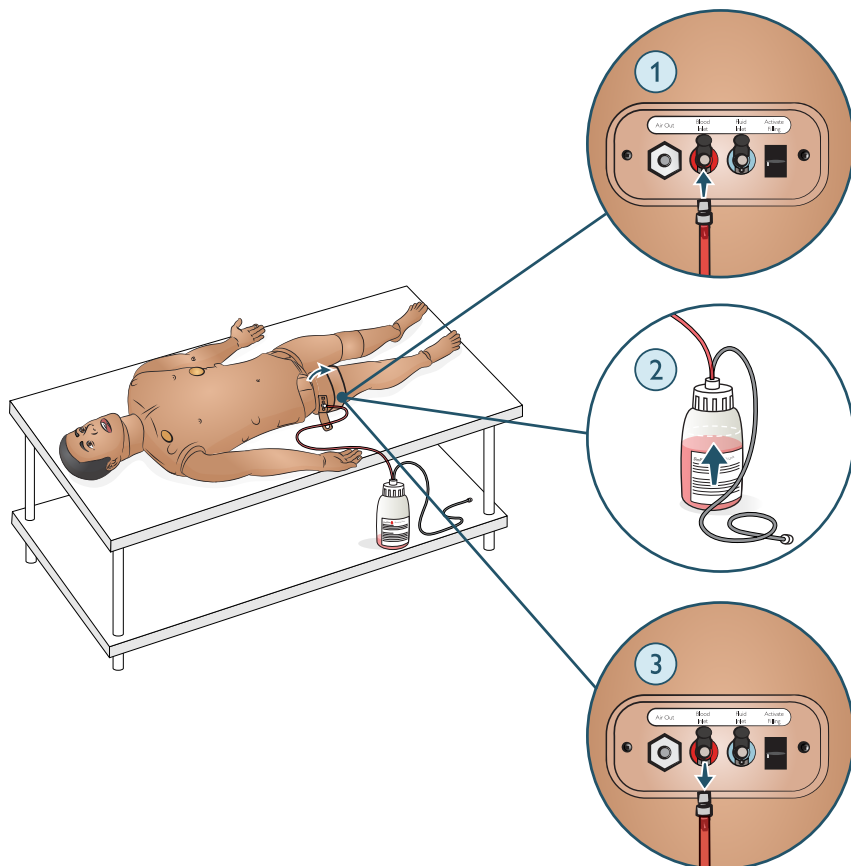

1. Connect an empty fill bottle to the blood inlet.
2. Fluid from the internal tank will automatically drain into the fill bottle.
3. When the flow stops, disconnect the blood connector.



WARNING

Connecting a full Blood Unit to a Patient Simulator with an already full internal tank will result in system overflow. Blood will drain out of the right leg. Repeatedly overflowing the system may damage the product.

**NOTE**

Place the fill bottle on the floor or below the Patient Simulator to facilitate emptying the fluids.



How-to video: [Empty Internal Blood Reservoir](#).

**NOTE**

The video shows the fluid inlets. Use the blood inlet here.

Empty the blood system

Ensure a wound is connected to a blood outlet. Refer to [Attach a wound \(p. 44\)](#) section.

1. Ensure that the Patient Simulator's power is ON.
2. Ensure that the Patient Simulator's internal blood reservoir is drained.
3. Press the Activate Filling button and the LED indicator will turn on.
4. Connect an empty fill bottle to the blood and air connector; the filling of air into the internal tank will start.
5. Open the Circulation and Fluids tab in LLEAP. Check the boxes for Upper and Lower port, then select Venous from the adjacent drop-down menus. Slide the bleeding rate controls to right to get maximum bleeding rates.
6. Wait until there is no more blood emitted from the simulator; then uncheck all boxes.
7. Disconnect the fill bottle.

Clean the blood system with isopropanol

1. Connect a fill bottle with isopropanol to the blood and air connector; the filling of isopropanol into the internal reservoir will start.
2. From LLEAP, again check the boxes for Upper and Lower port (making sure Venous bleeding and maximum blood rates are still selected).
3. Allow the blood system to flush until clear fluid runs out of all outlets.
4. When finished, press Activate Filling to deactivate the filling procedure. The LED indicator on the Activate Fill will turn off.
5. Leave the bottle connected for approximately 30 seconds to let the internal tank drain completely.

6. In LLEAP uncheck all boxes and slide bleeding rate controls to the left. And then disconnect bottle.

Flush the isopropanol out of the blood system

1. Connect an empty fill bottle to the fill panel.
2. Connect an empty fill bottle to the blood and air connector; the filling of air into the internal tank will start.
3. Open the Circulation and Fluids tab in LLEAP. Check the boxes for Upper and Lower port, then select Venous from the adjacent drop-down menus. Slide the bleeding rate controls to right to get maximum bleeding rates.
4. Wait until there is no more fluid emitted from the Patient Simulator, then press Activate Filling once again so that filling is disabled (LED indicator should be turned off).
5. In LLEAP uncheck all boxes and move the sliders all the way to the left. Disconnect the fill bottle and wounds.



CAUTION

Never store the Patient Simulator with isopropanol or liquid in the Fluid or Blood System.

 How-to video: [Clean the Blood System](#).



NOTES

- *The video shows the fluid inlets. Use the blood inlet here.*
- *During the cleaning procedure – Tank empty warning - may occur in LLEAP Software. This message can be disregarded during the cleaning procedure.*

Cleaning the fluid system

The fluid system should be cleaned thoroughly once or twice a month.



NOTE

During the cleaning procedure – Tank empty warning - may occur in LLEAP Software. This message can be disregarded during the cleaning procedure.

 How-to video: [Clean the fluid system](#).



NOTE

The video shows the fluid inlets. Use the fluid inlet here.

ACCESSORIES

Trauma modules

Trauma modules can be fitted to the Patient Simulator to simulate bleeding patient cases.

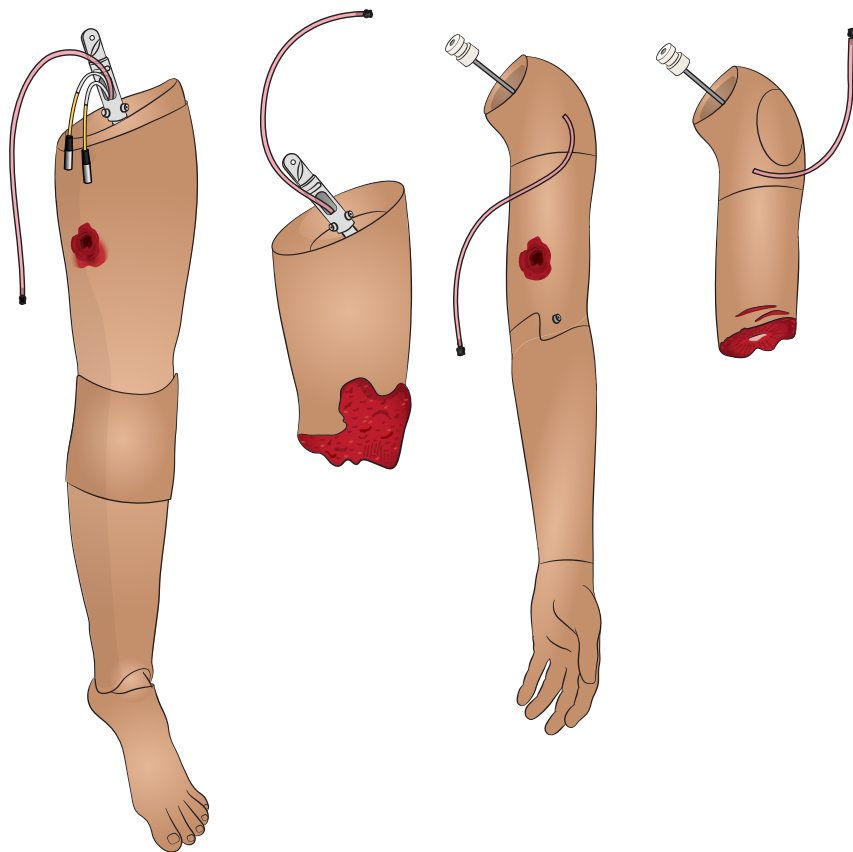

After the simulation is complete, leave the trauma modules connected, and clean according to the instructions in [Cleaning the Blood System \(p. 85\)](#).



NOTES

- *The SimMan CC arm adaptor kit is required to connect the trauma arm modules.*
- *There will be no automatic non-invasive blood pressure functionality on the right arm when it is used with one of the left trauma arms.*

 How-to video: [Blood Flow Adjustment](#) in LLEAP.

Attaching trauma arm

Before starting, follow the [Open the torso skin \(p. 59\)](#) procedure.

Move the stomach foam carefully to one side to avoid pulling on connecting tubes and cables.

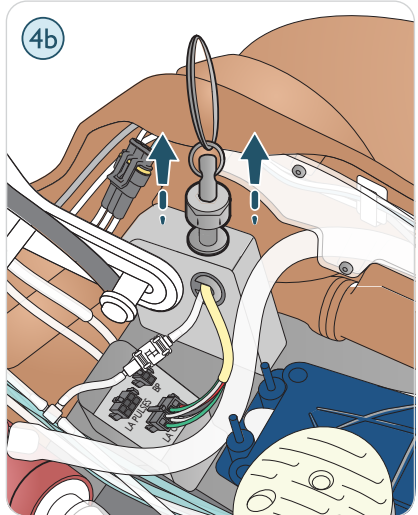
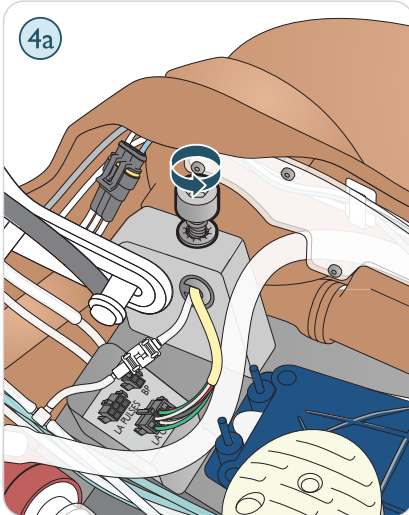
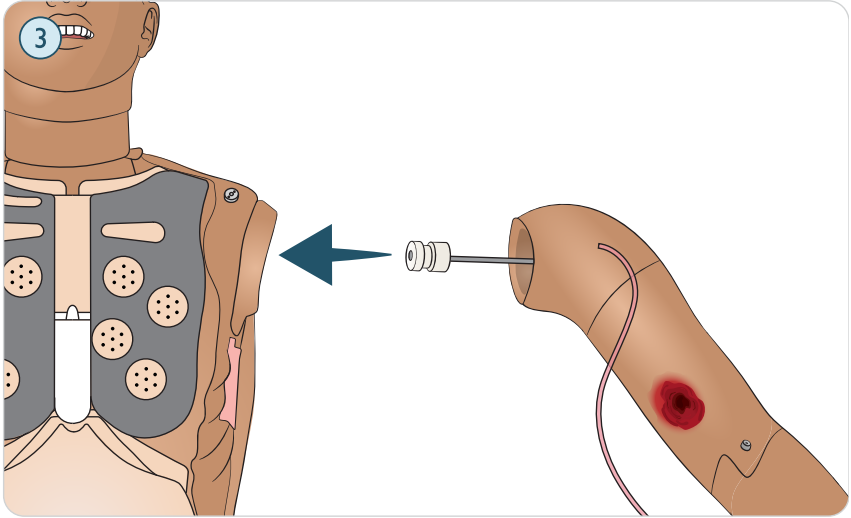
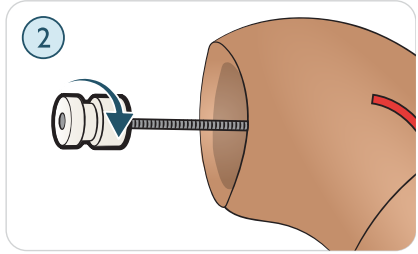
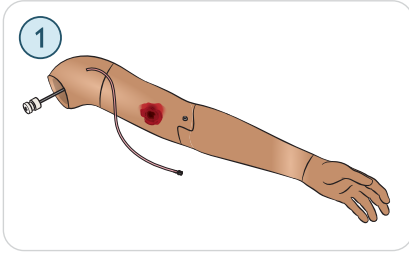

1. Select either the SimMan CC Amputation or Gunshot Arm with Arm Adapter and Adapter Screw.
2. Unscrew the Adapter Screw.
3. Insert the arm into the shoulder bracket.
4.
 - a. Tighten the arm bolt to secure.
 - b. Push down the arm bolt.

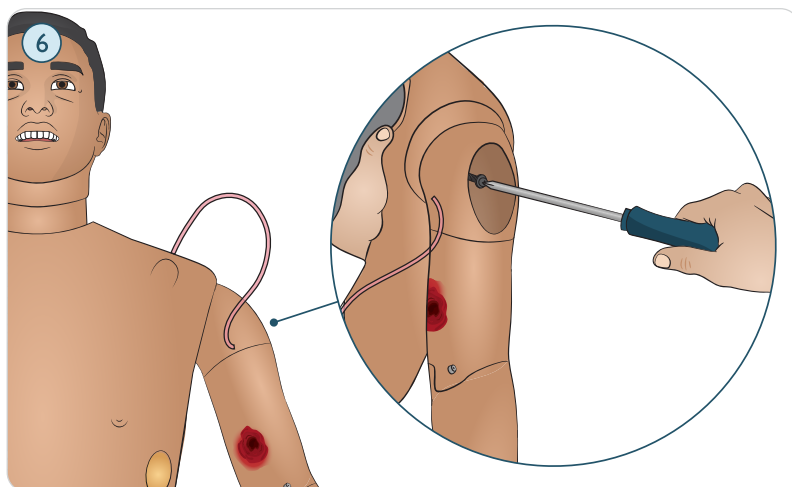
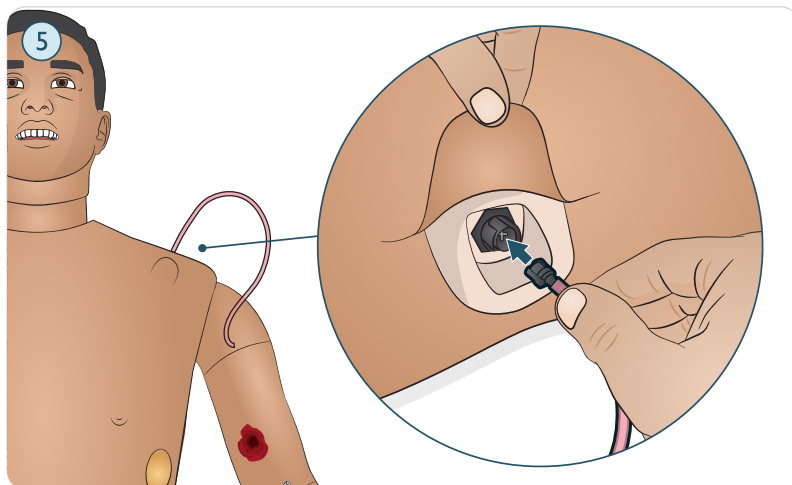

5. Attach the tube to the desired blood port.

6. Tighten the screw to adjust the range of the arm motion with a screwdriver.



CAUTION

Do not over rotate arm. Over rotating the arm may cause the red vinyl tubing to disconnect.

Attaching the trauma left leg

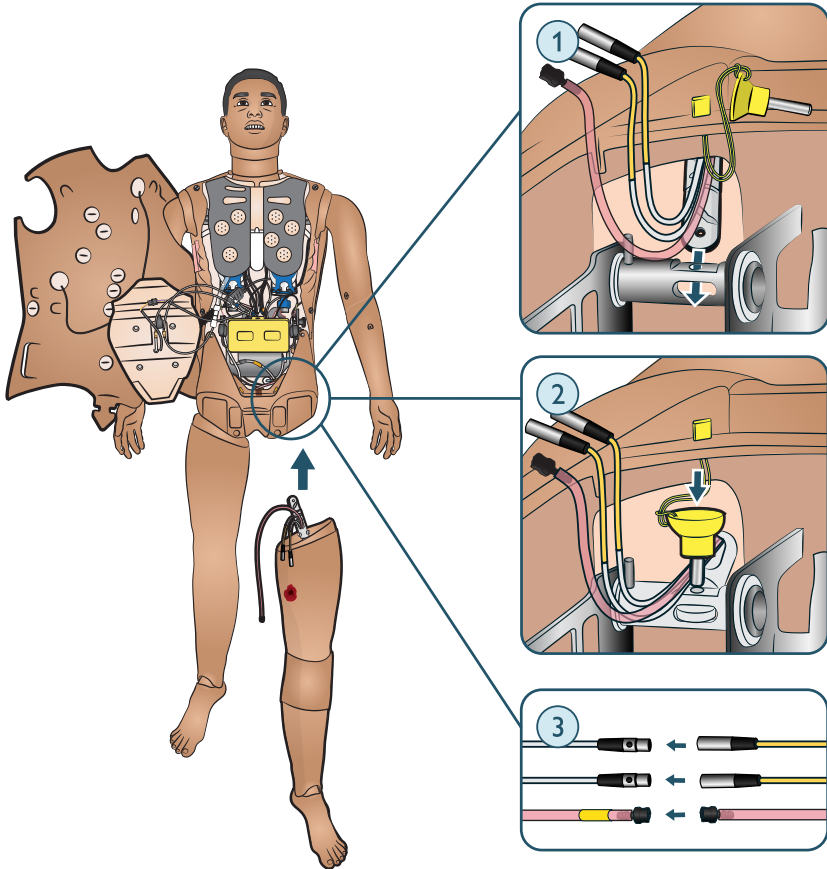

1. Insert the trauma leg into the leg socket.

2. Insert the thumb lock pin, ensuring the leg is properly fixed into place.
3. Connect the cables and tube.

Transport and storage

Before storage or shipping

- Flush the simulator's fluid and blood systems with isopropanol 60%-70%, and then leave to dry to remove any isopropanol residue from the system.
Refer to [Cleaning the Fluid System \(p. 88\)](#) and [Cleaning the Blood System \(p. 85\)](#).
- Detach the Patient Simulator's legs from the torso and pack into their cases.

Battery storage and transport

- Store in a refrigerator i.e. temperature 0°C - 4°C (32°F - 40°F).
- The two simulator batteries can be transported in the Patient Simulator during air freight. When transporting spare batteries contact the airline or freight company for the latest transport regulations.



WARNINGS

- *The suitcases are heavy. Always ensure that they are firmly secured during transportation and storage so as not to cause personal injury or damage to the product.*
- *When unpacking the torso, do not use the leg openings as lifting points, use the genitalia opening! The slides might come loose and cause personal injury or product damage.*



CAUTIONS

- Do not store this product outside the storage conditions specified in the Important Product Information.
- Store simulator in a clean, dry area. Storage in a damp area will cause corrosion of electronic parts.
- Do not store the Patient Simulator with fluid.
- Do not store the Patient Simulator with wet injection pads.
- Do not store the Patient Simulator with tape or other adhesive products attached to the skin.
- Patient Simulator should be stored on its back with adult cervical collar in place.
- Do not stack Patient Simulators or store with heavy objects on top.
- The Patient Simulator's neck should be supported at all times during transport.
- Do not try to lift the Patient Simulator alone, unless this is part of a simulation where correct lifting techniques shall be demonstrated.
- Lifting the Patient Simulator alone may lead to muscle strains.
- Ensure that the Patient Simulator is properly secured during transportation to prevent personal injury or damage to the product.
- Always keep the thumb lock pins inserted in the hip joint (leg) connections. The pins could wrap around internal cables and tubes, risking damage.

© 2024 Laerdal Medical AS. All rights reserved.



Laerdal Medical AS
P.O. Box 377
Tanke Svilandsgate 30, 4002 Stavanger, Norway
T: (+47) 51 51 17 00

20-21551 Rev B

laerdal.com



Laerdal
helping save lives