

# Little Anne

## Chest Plate Installation Guide

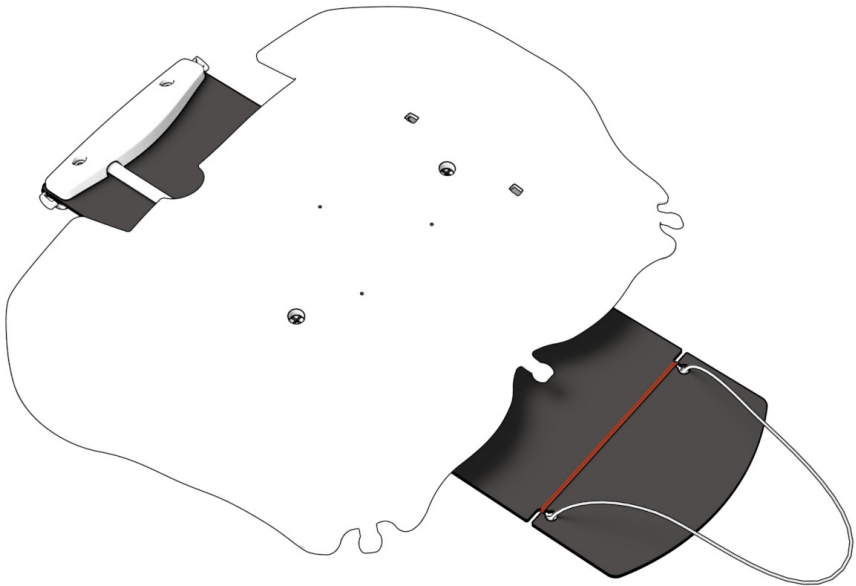

# Installation

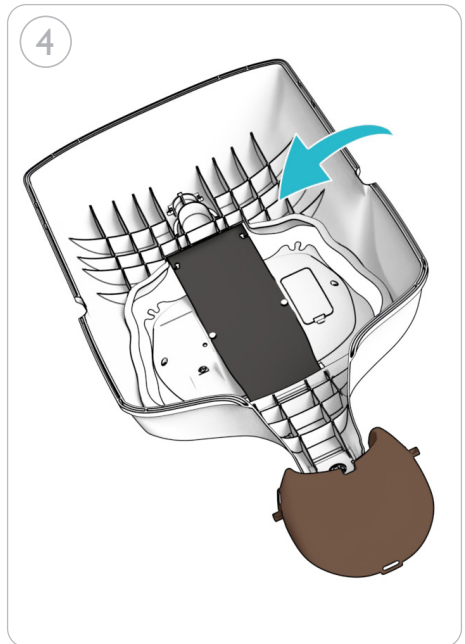
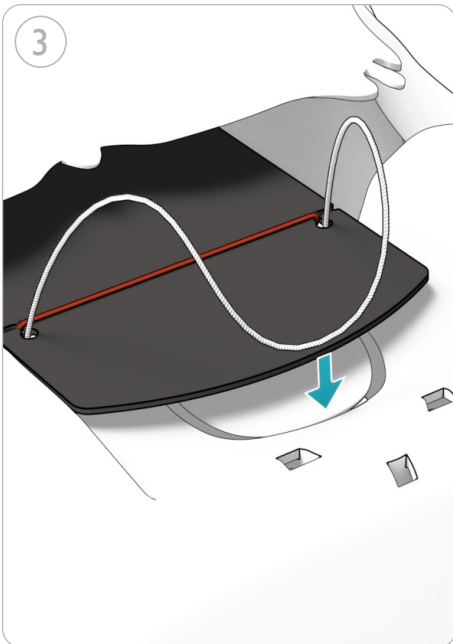
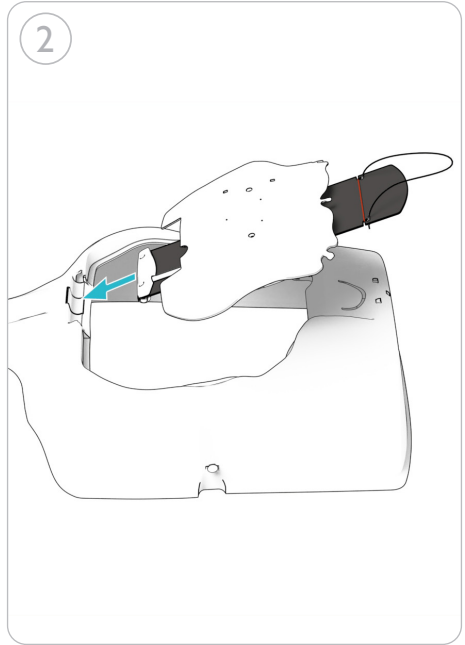
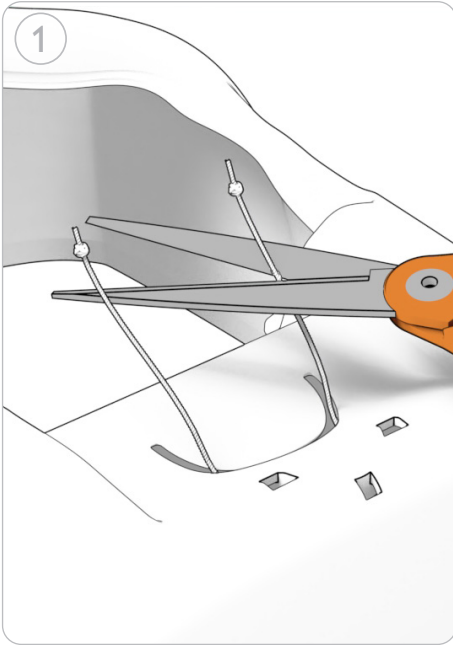

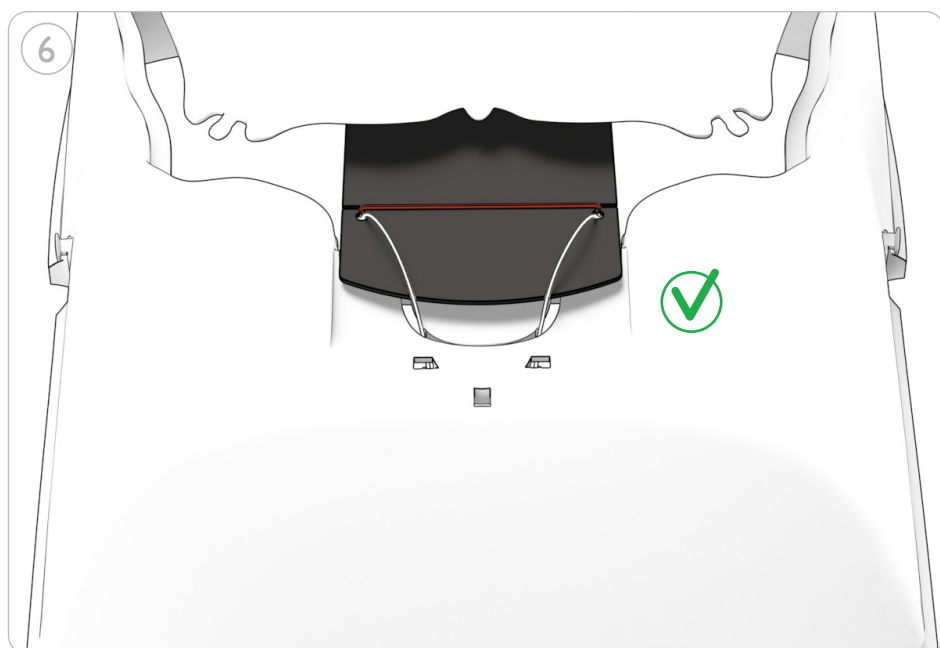
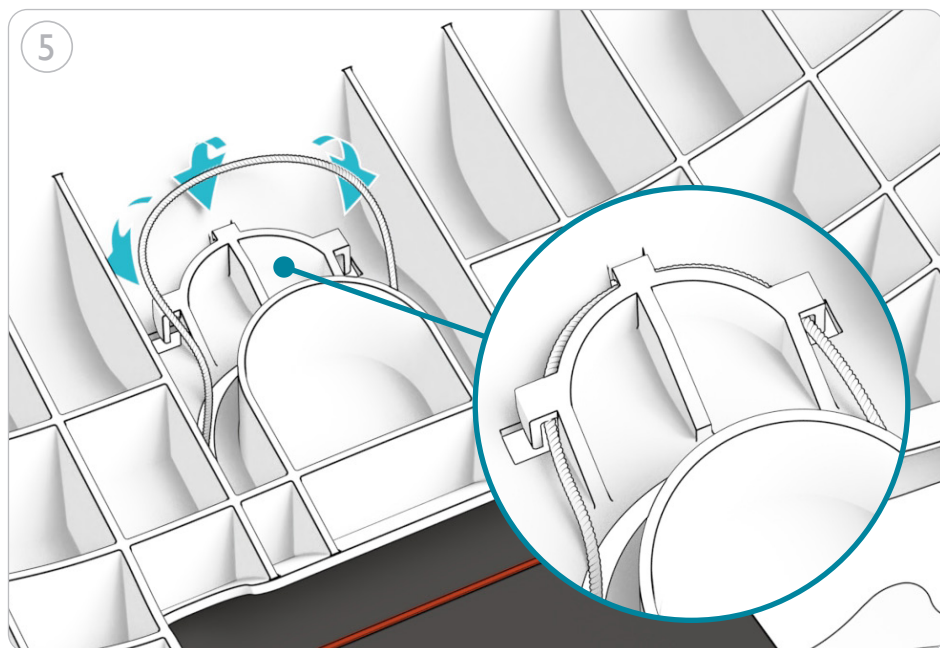

© 2024 Laerdal Medical AS. All rights reserved.



Laerdal Medical AS  
P.O. Box 377  
Tanke Svilandsgate 30, 4002 Stavanger, Norway  
T: (+47) 51 51 17 00

20-21589 Rev.A

[www.laerdal.com](http://www.laerdal.com)



**Laerdal**  
helping save lives