

Nursing Anne Simulator Male Kit

Installation Guide

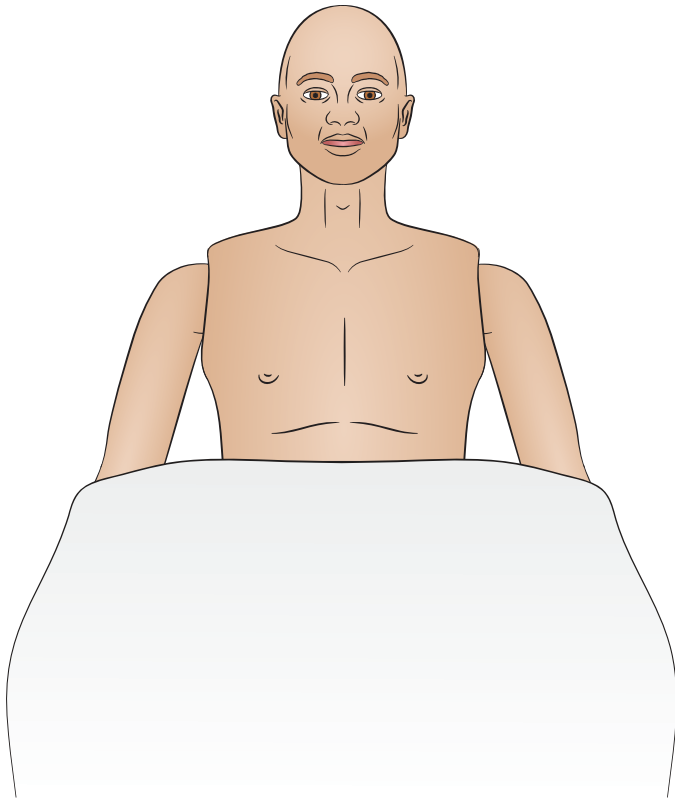

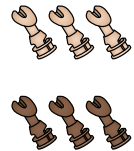

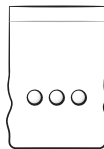
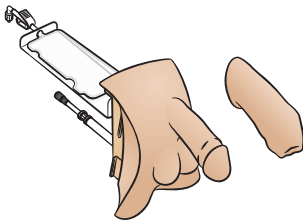
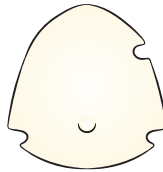
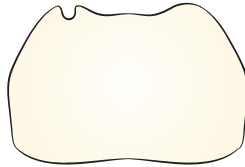
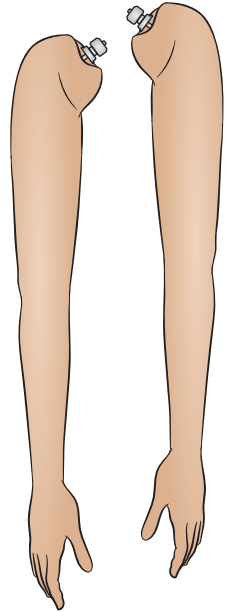
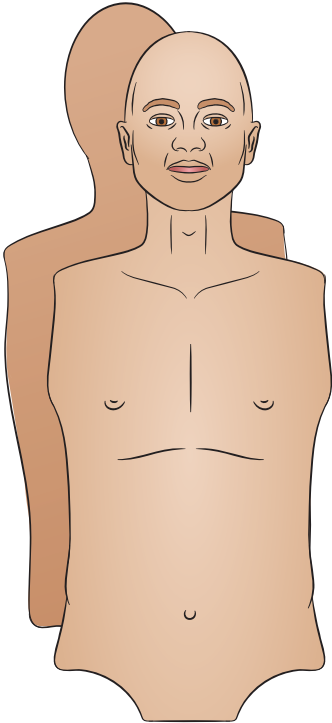
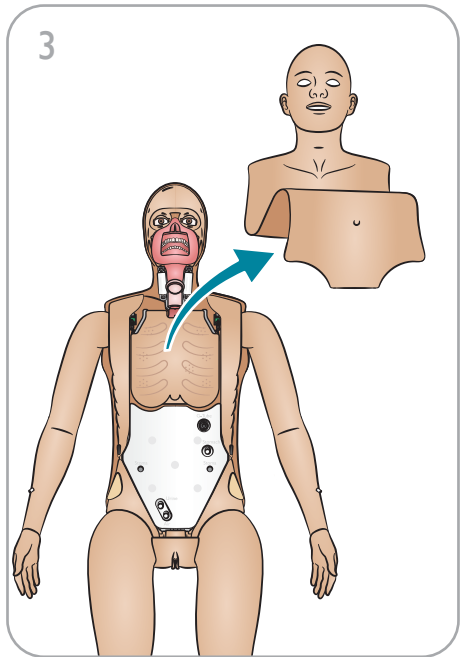
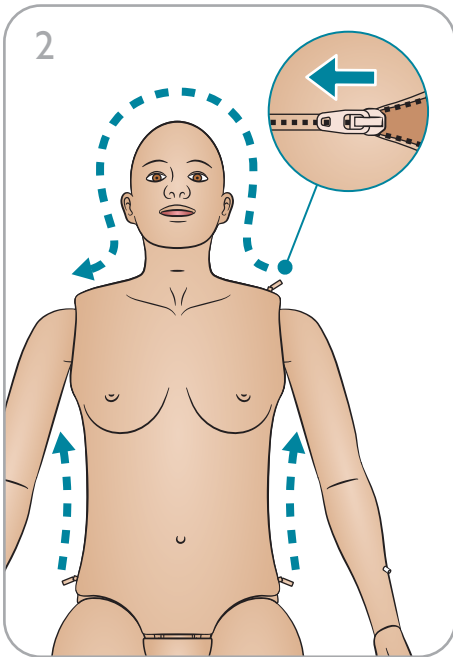
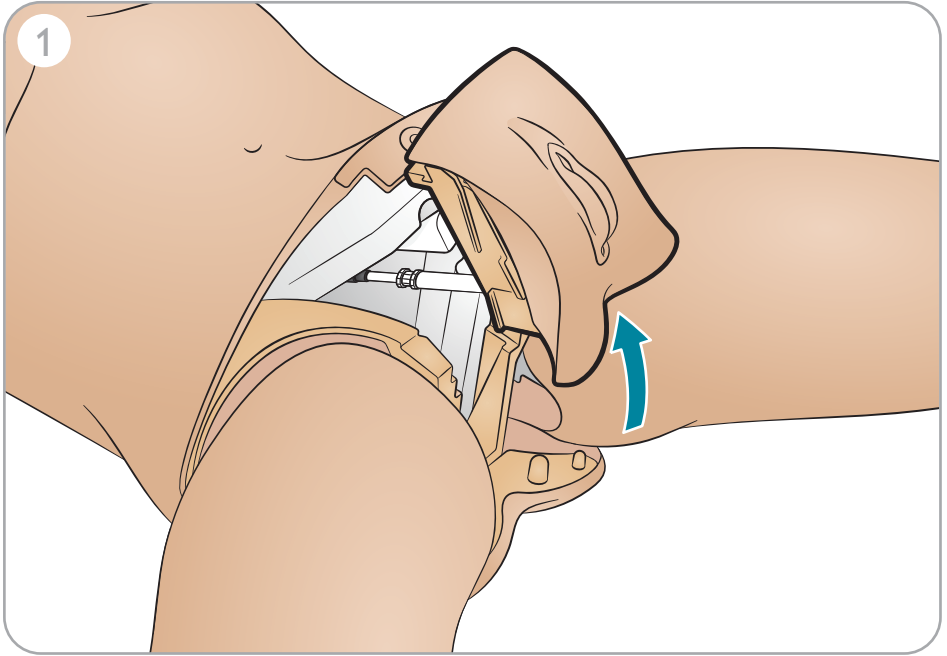

4

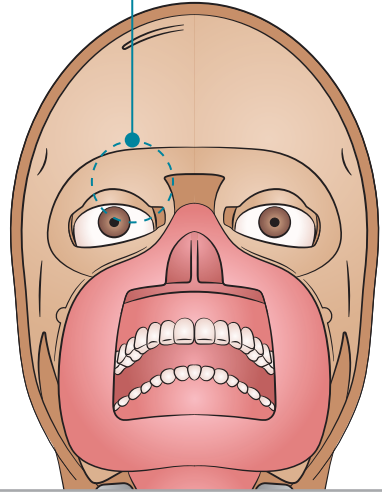
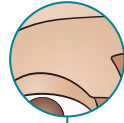
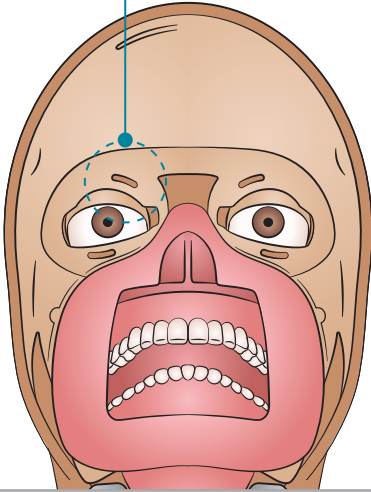
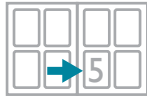

5

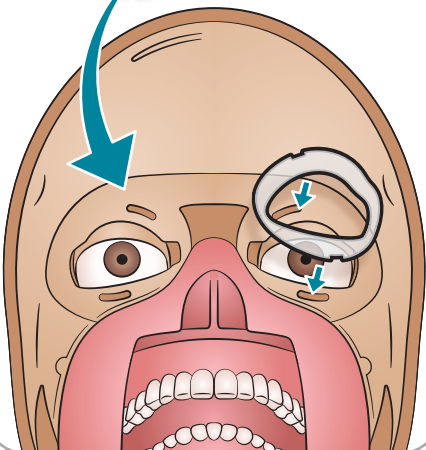

6

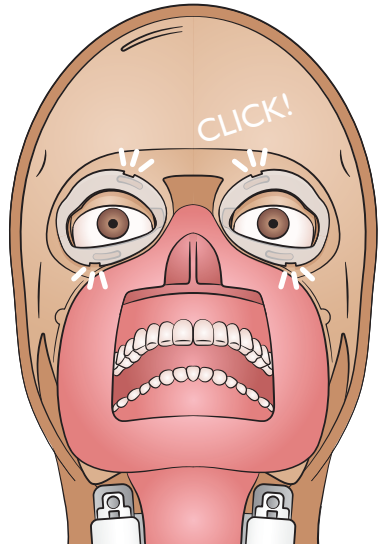

7

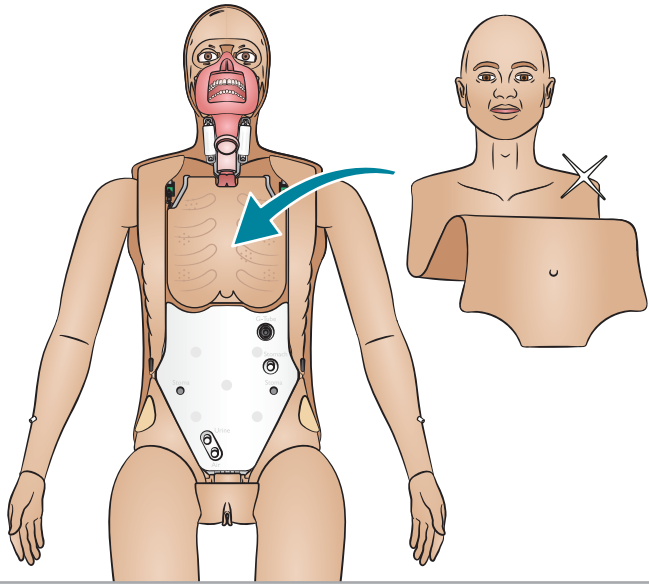

8

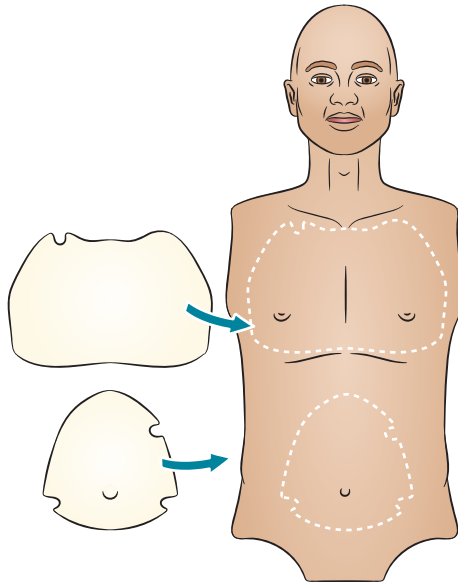

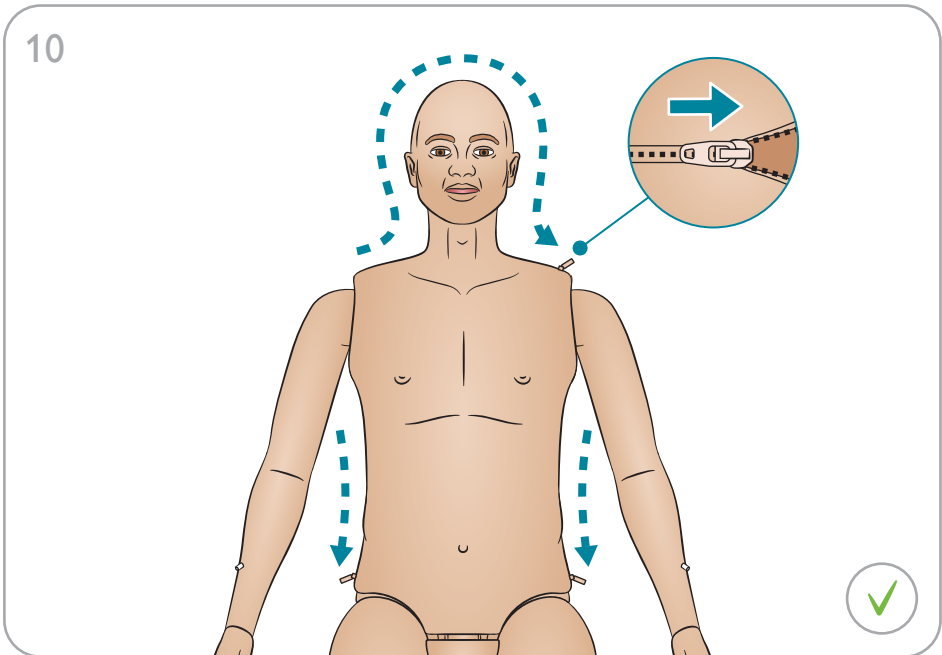
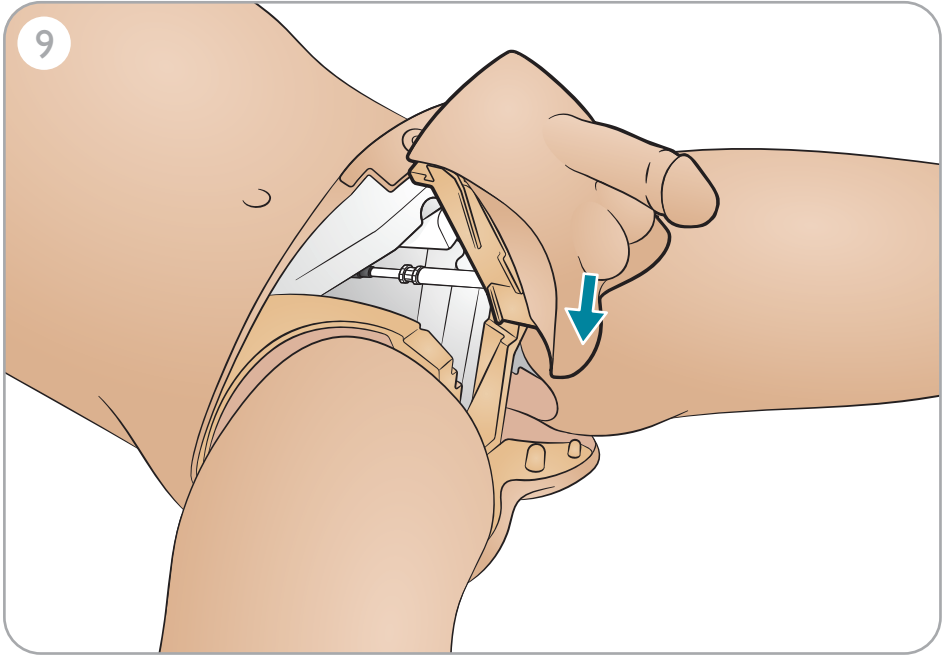

Arms

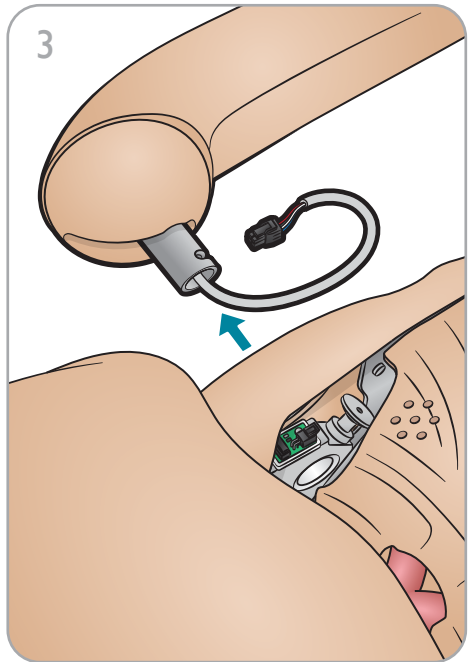
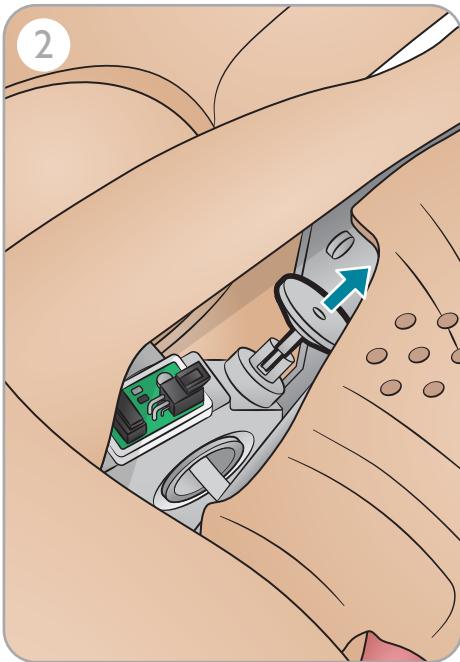
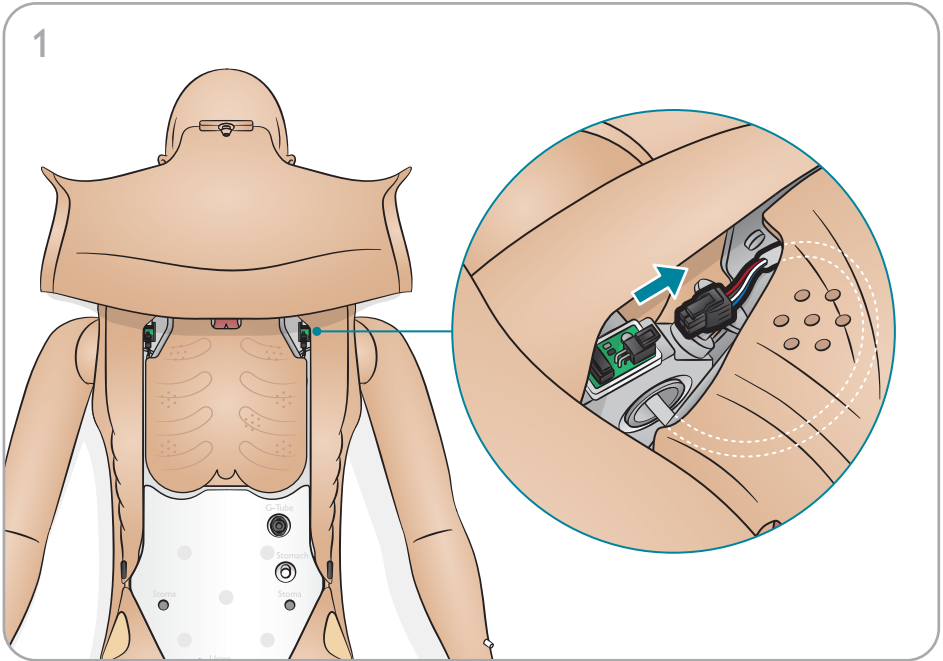

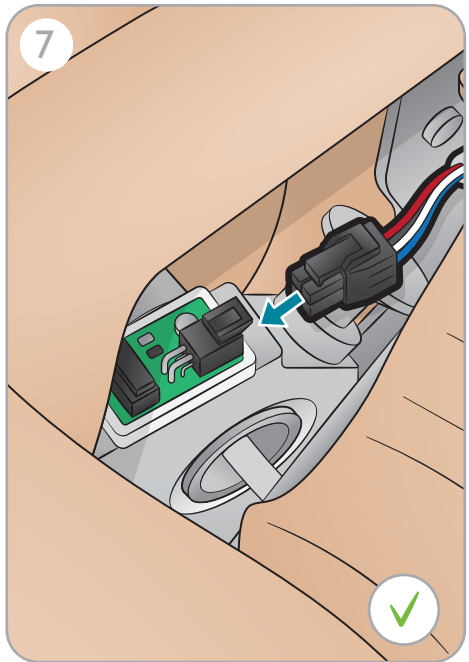
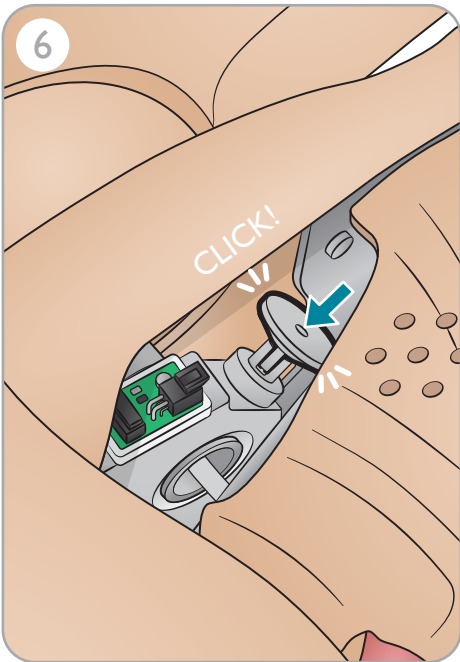
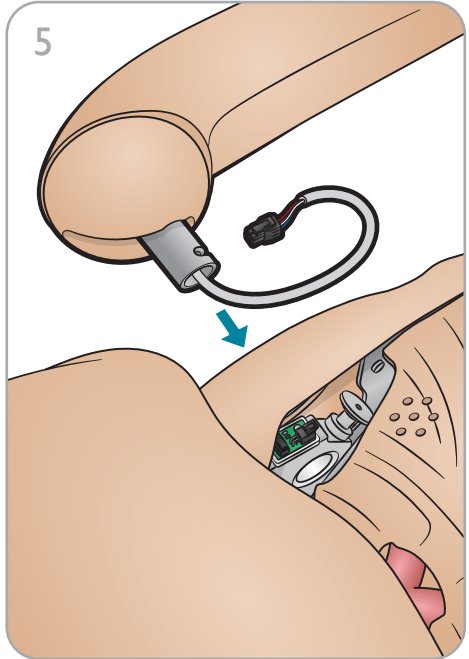
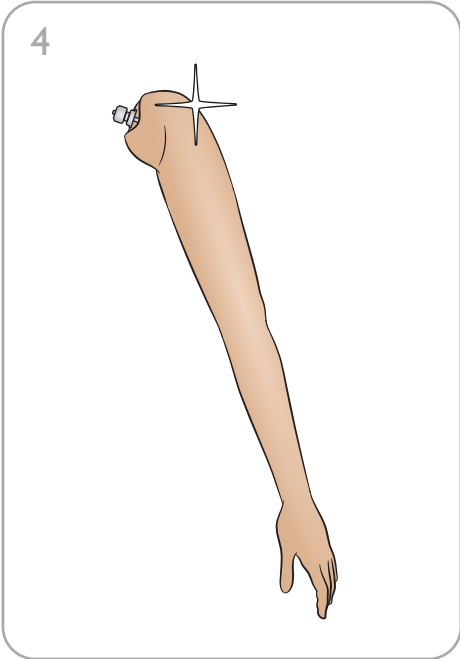

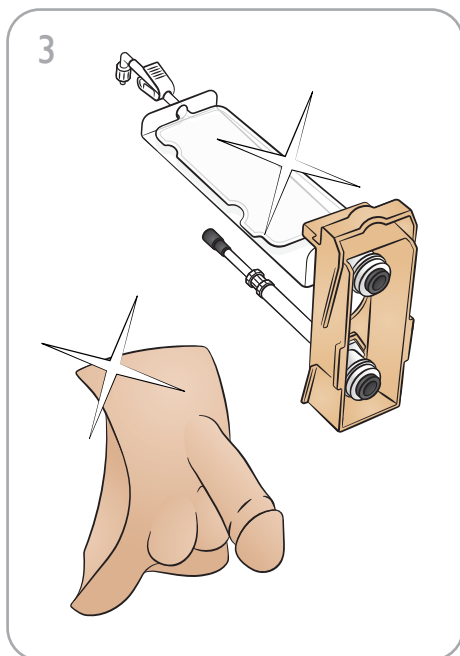
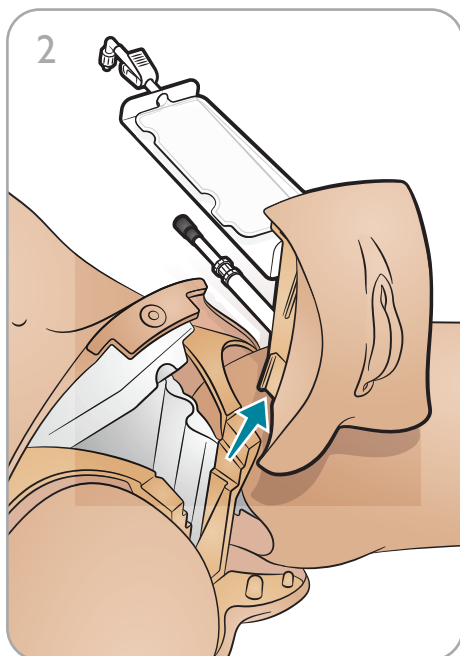
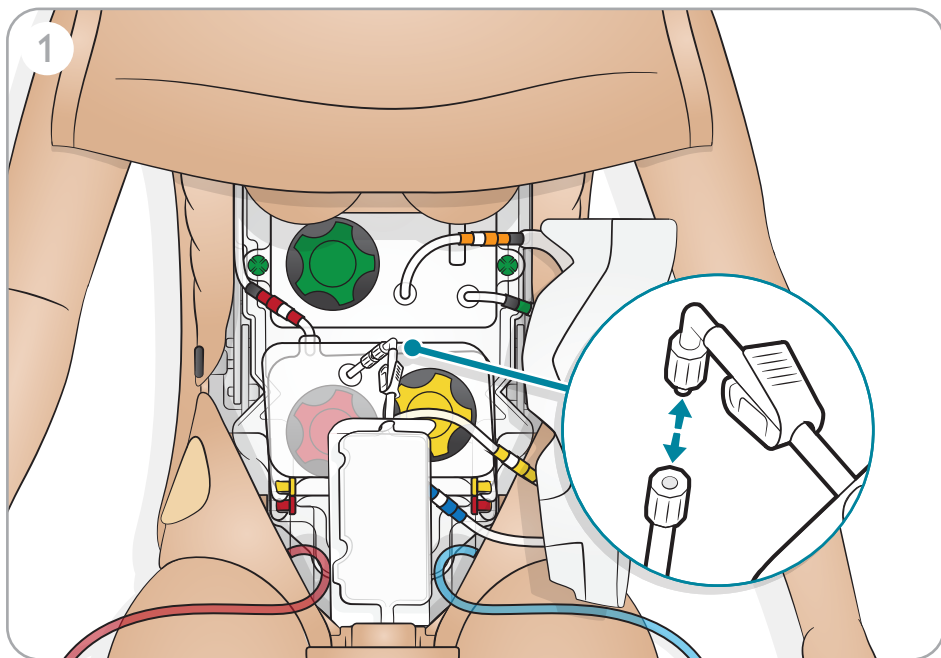

4

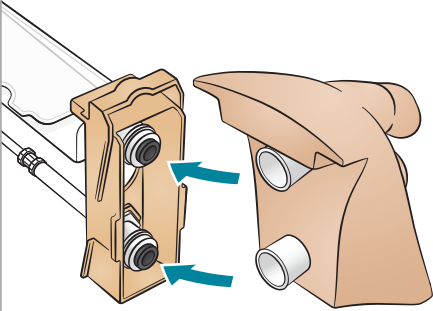

5

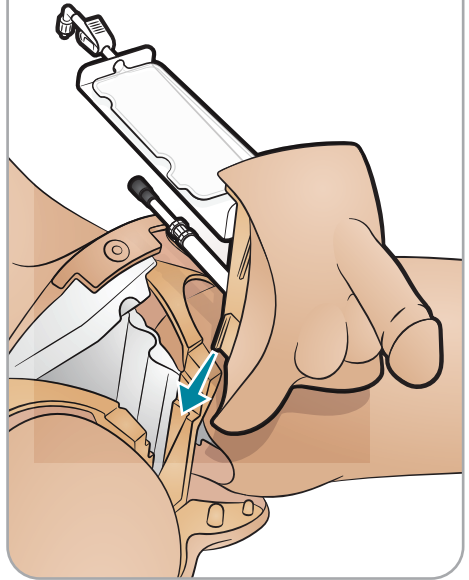

6

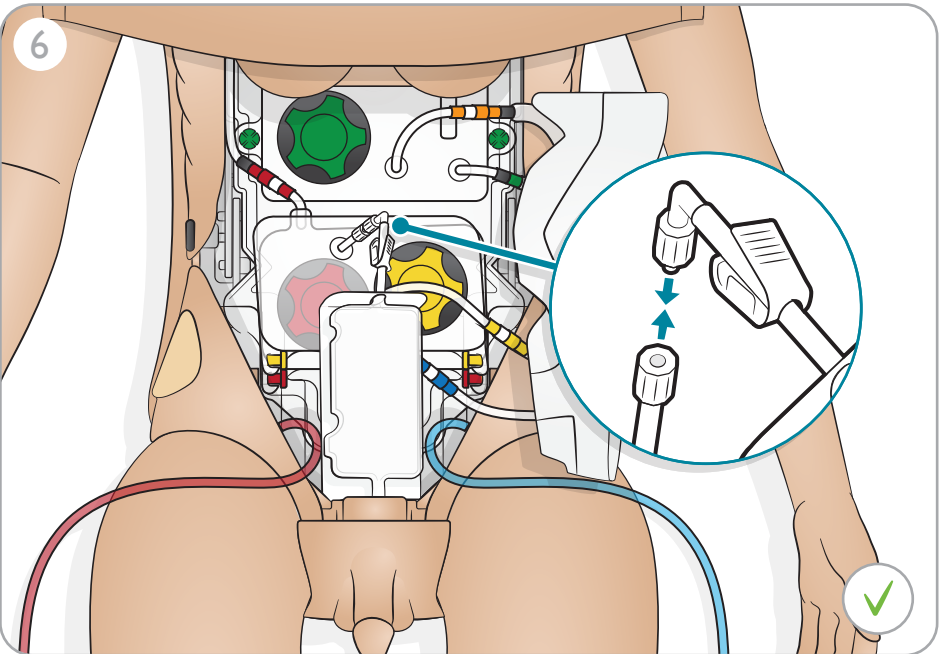

© 2022 Laerdal Medical AS. All rights reserved.



Manufacturer: Laerdal Medical AS
P.O. Box 377
Tanke Svilandsgate 30, 4002 Stavanger,
Norway

T: (+47) 51 51 17 00

20-19616 Rev A

www.laerdal.com



Laerdal
helping save lives