

Nursing Anne Simulator

Geriatric Kit

Installation Guide

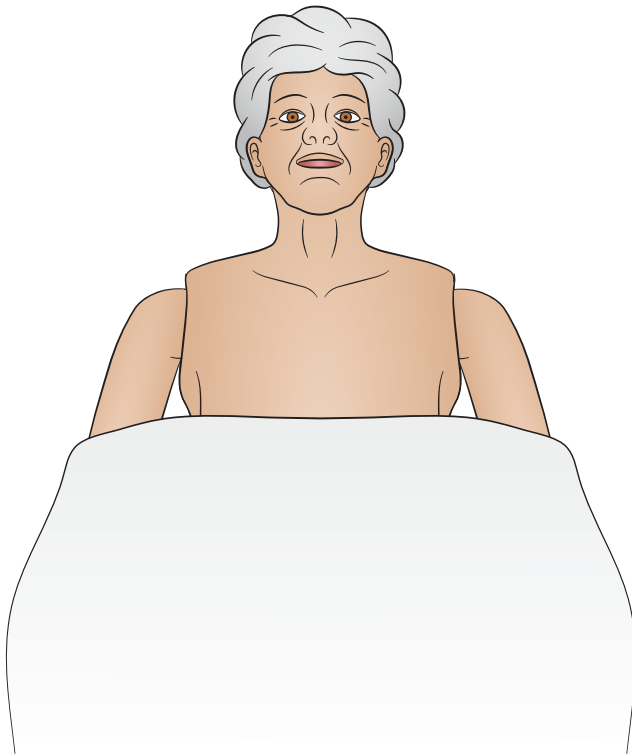

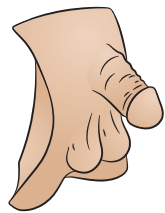
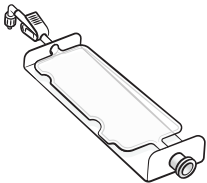
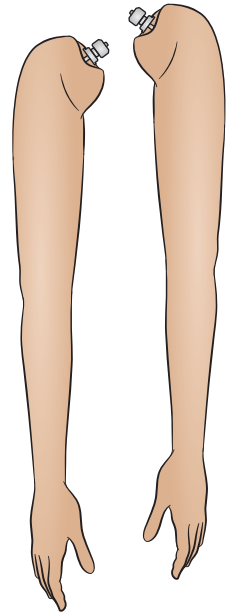
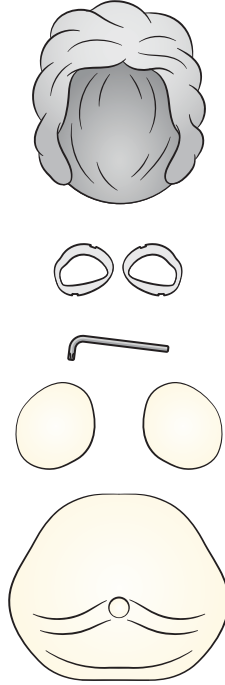
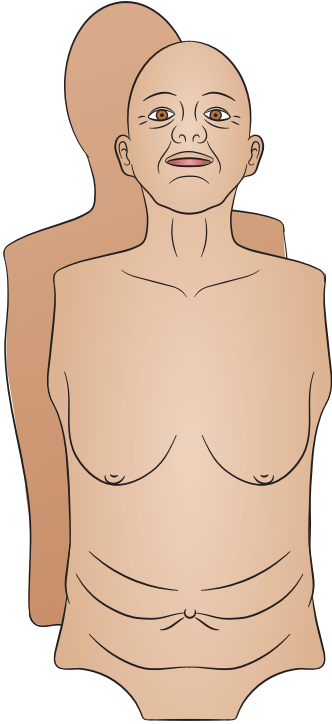

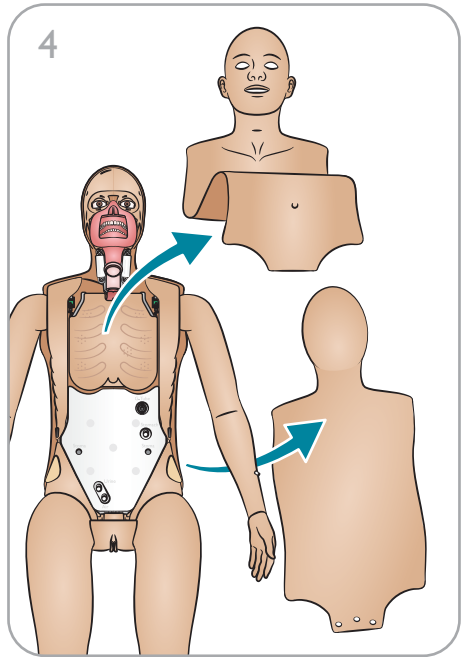
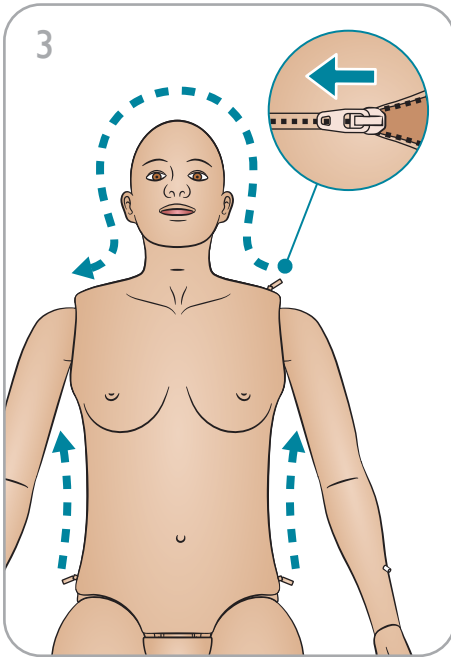
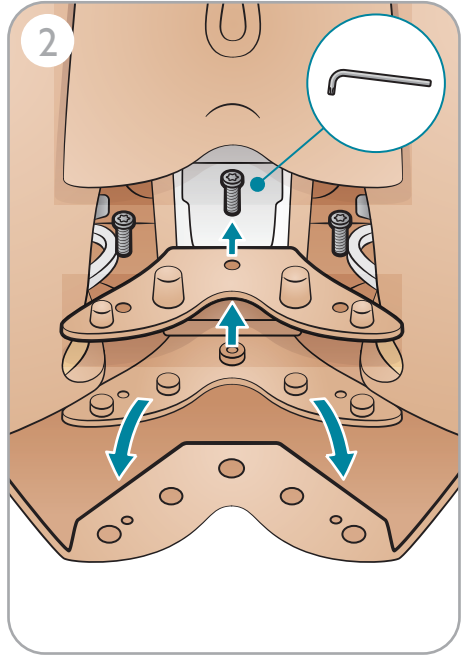
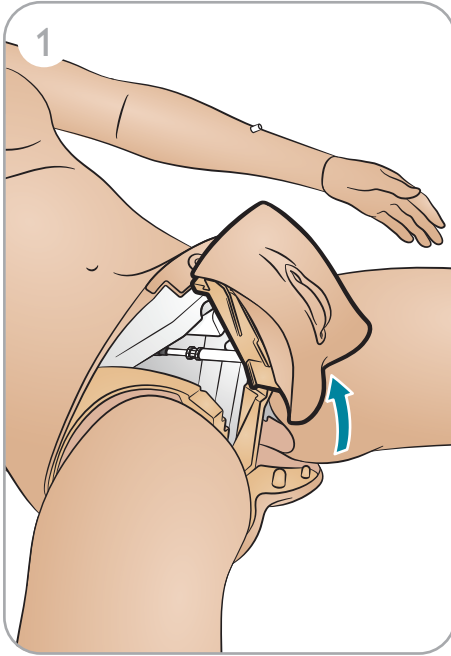

5

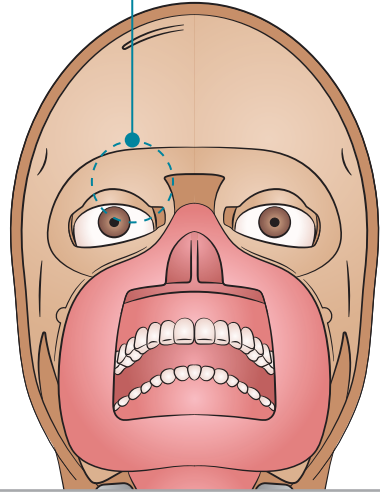
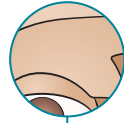
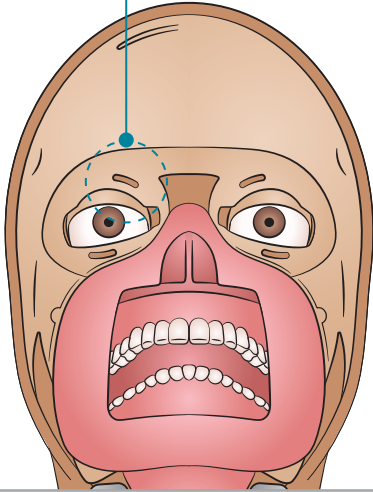
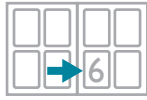

6

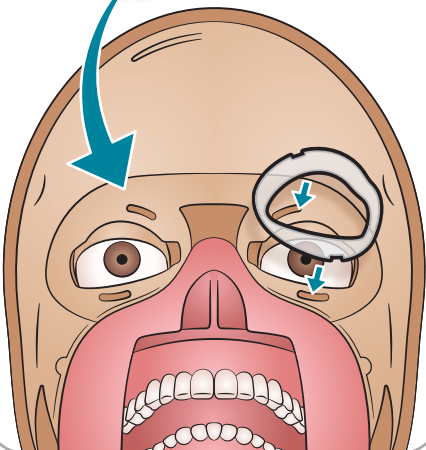

7

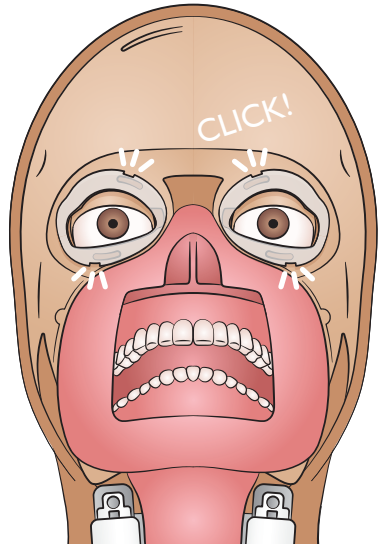

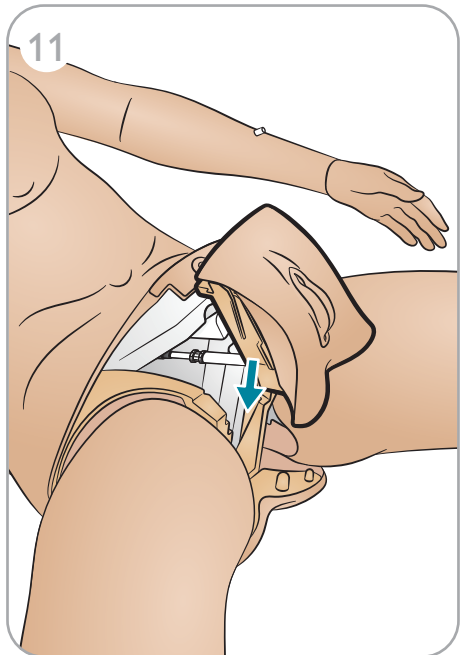
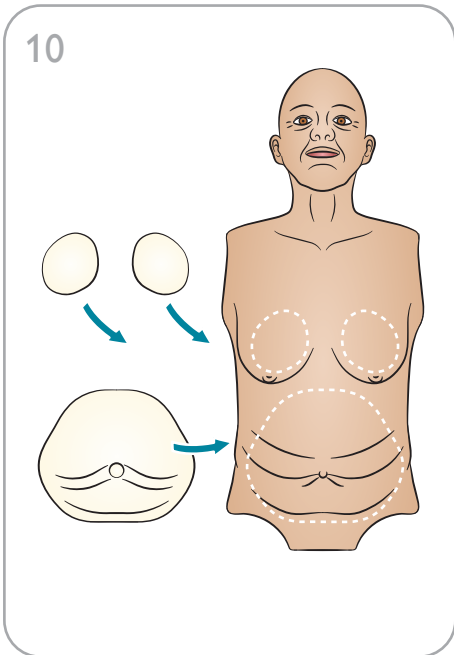
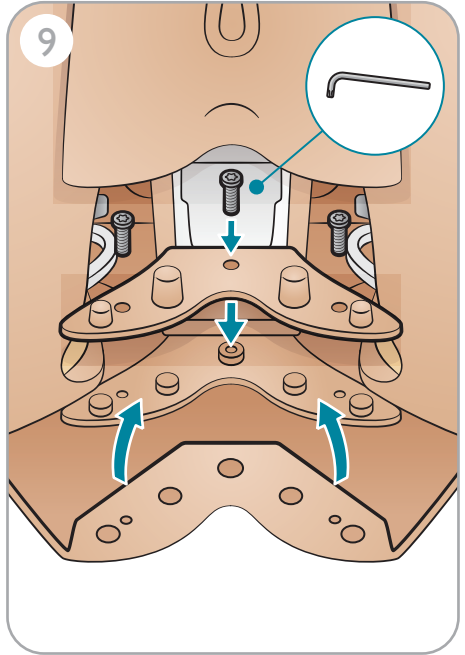
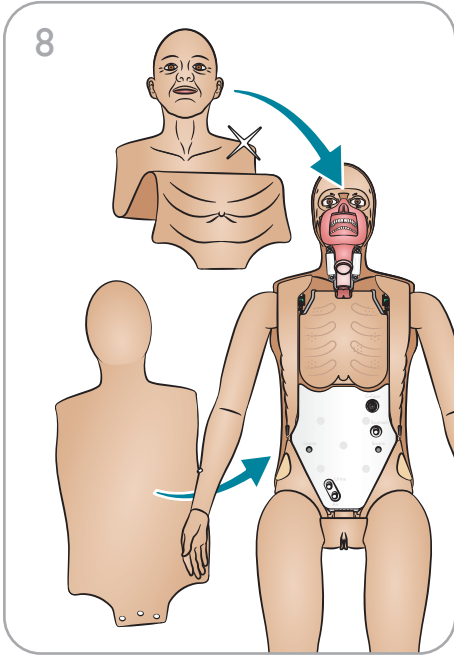

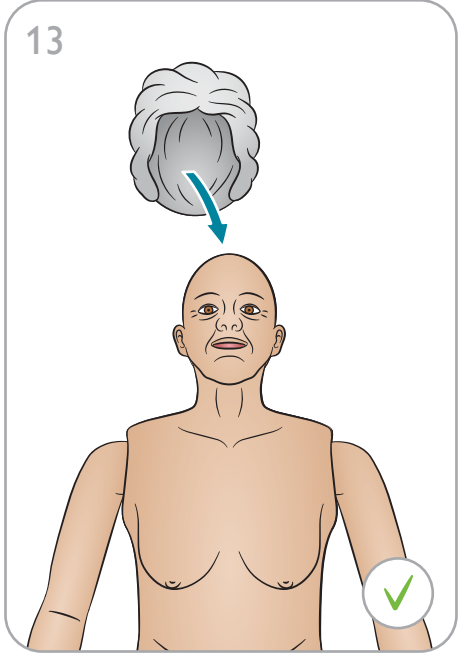
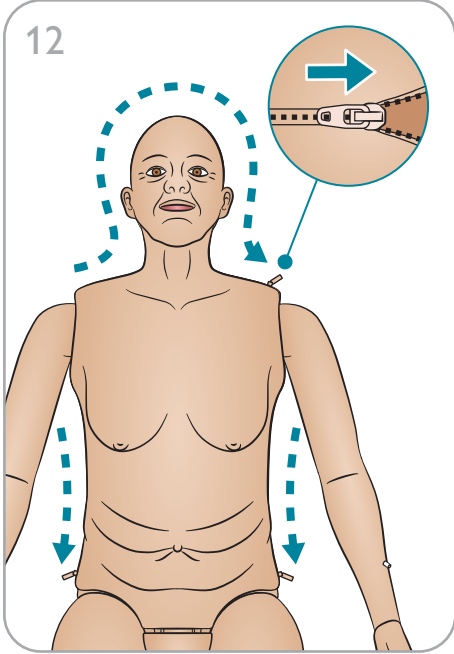

Arms

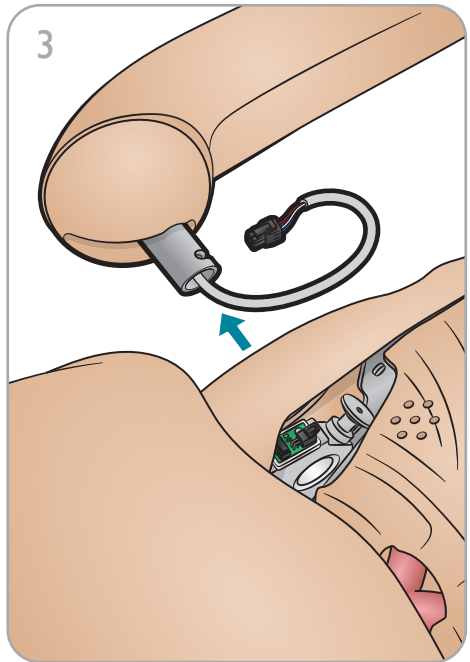
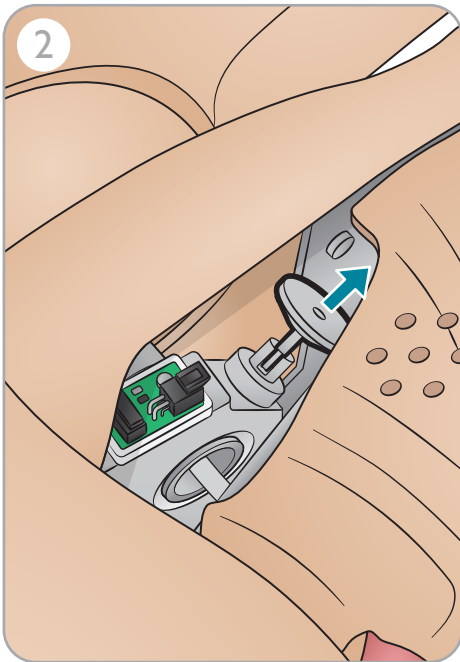
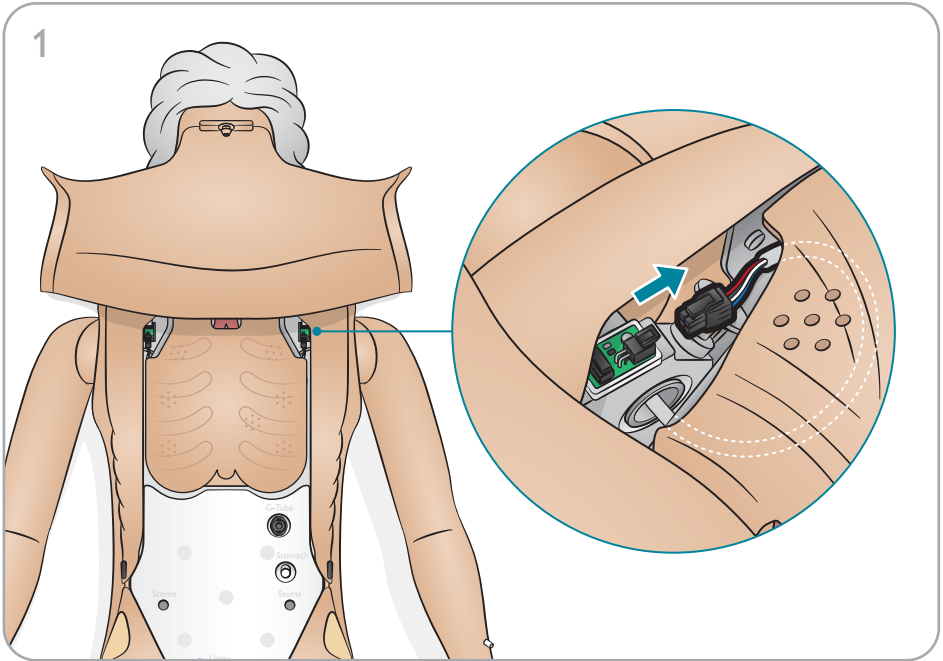

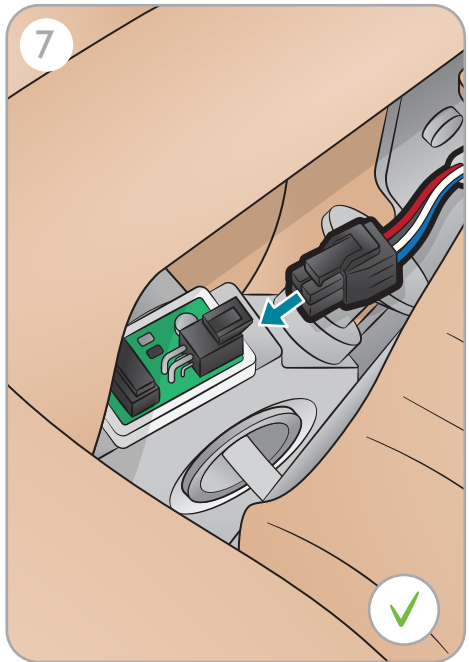
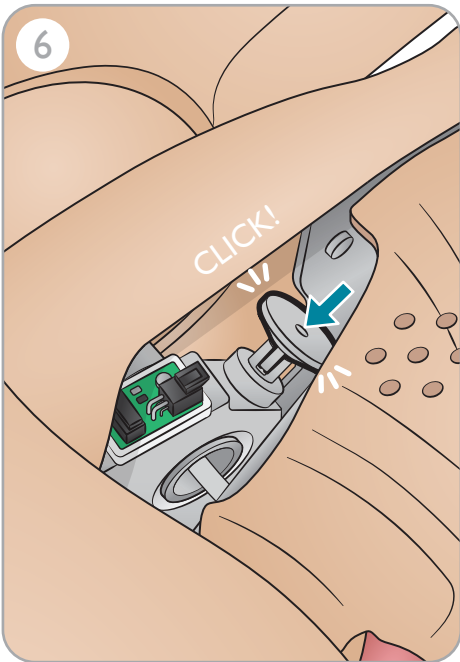
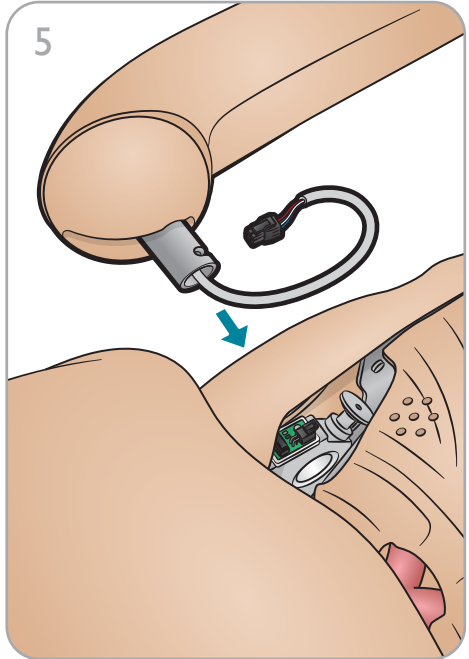
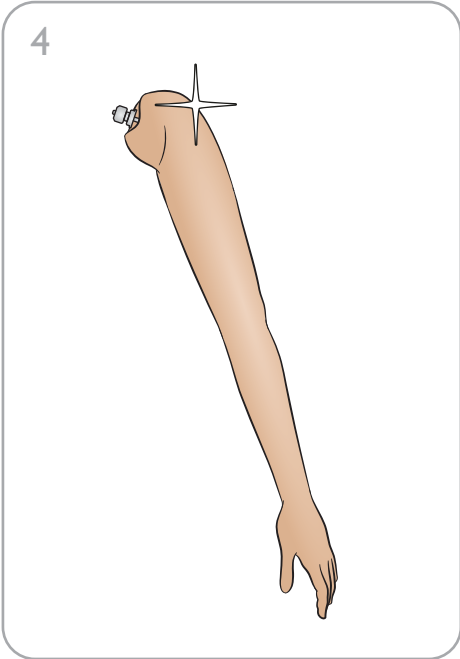

1

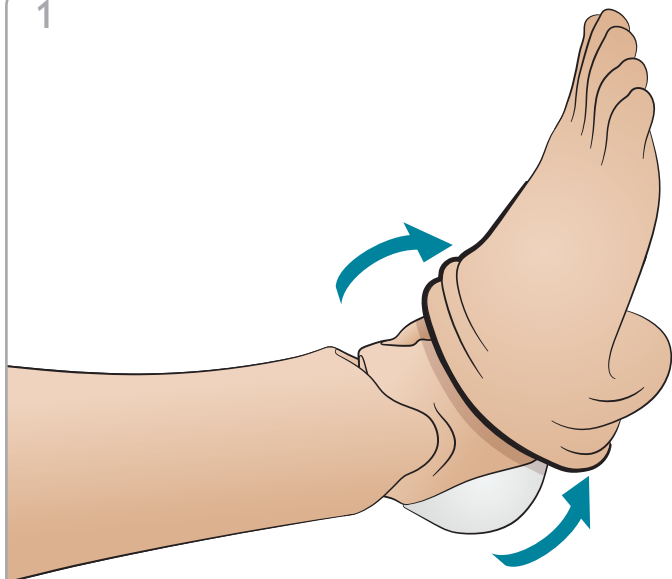

2

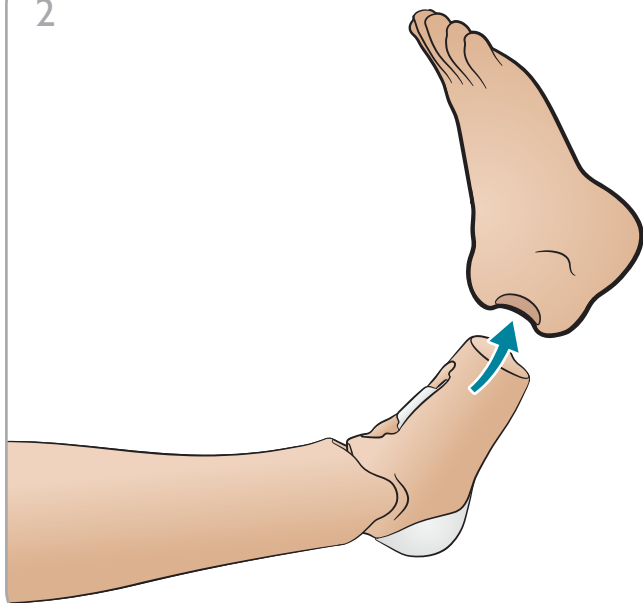

3

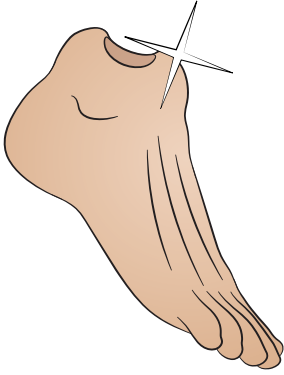

4

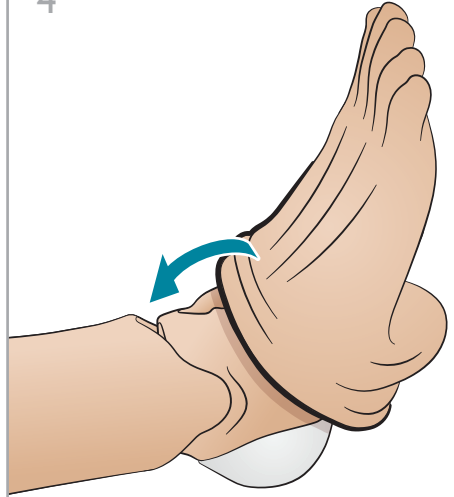

5

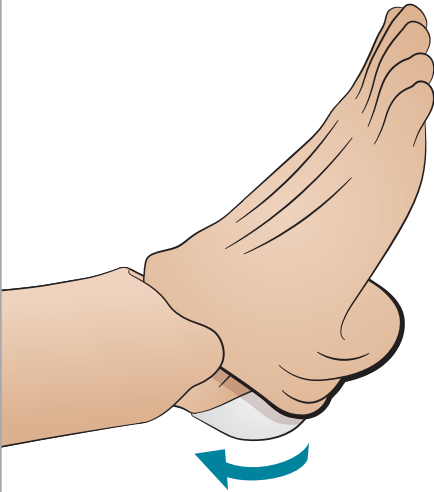

6

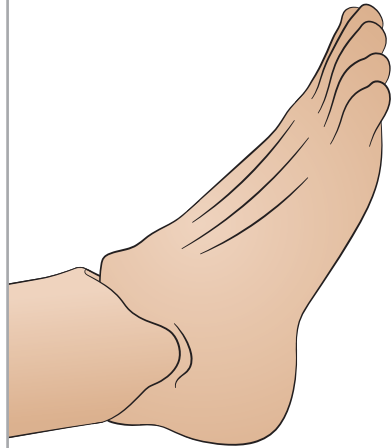

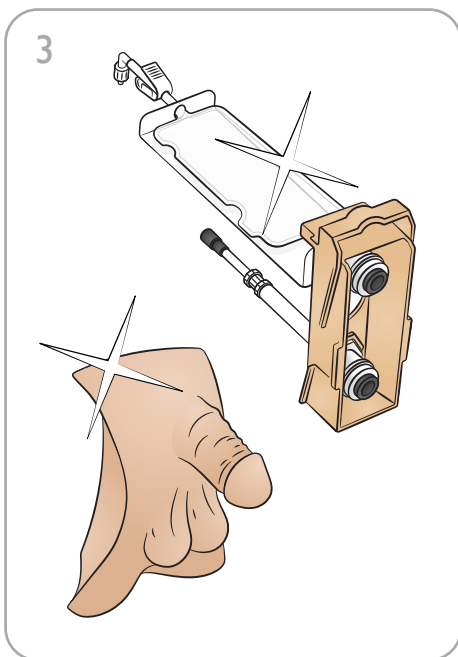
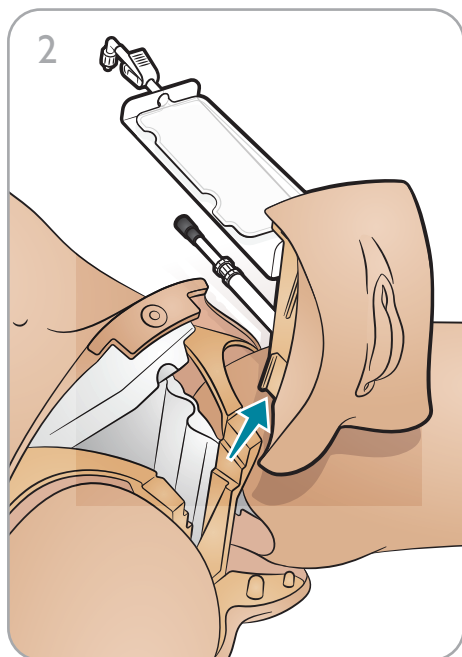
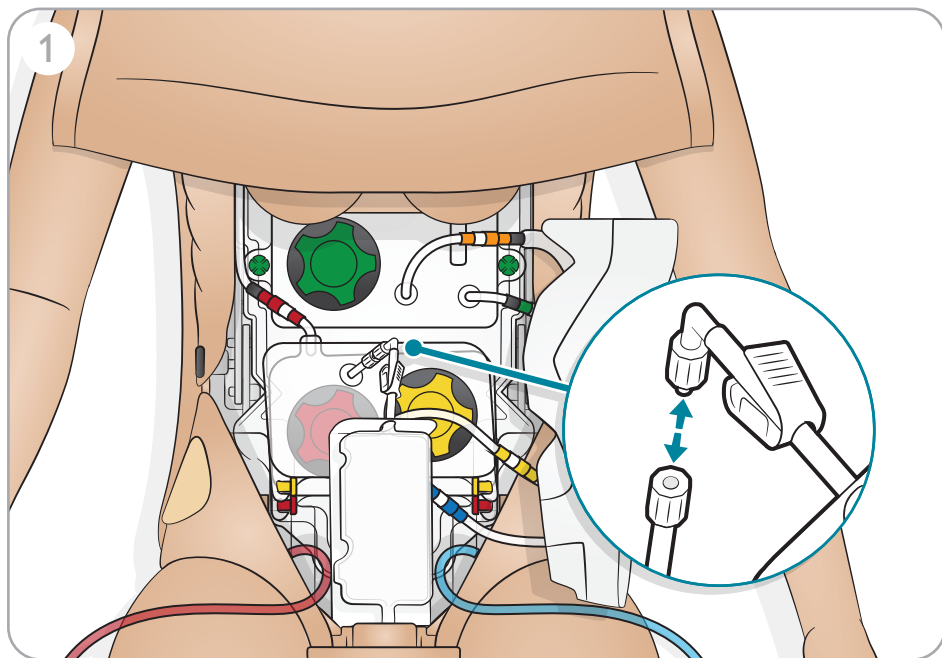

4

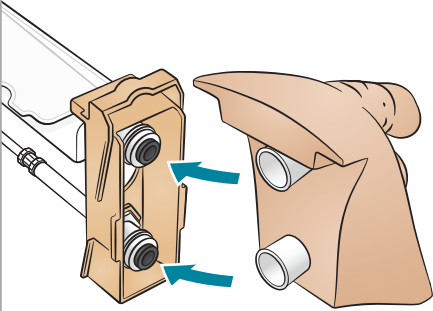

5

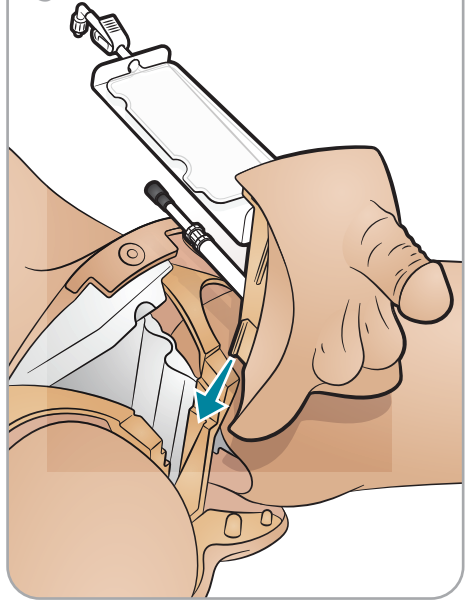

6

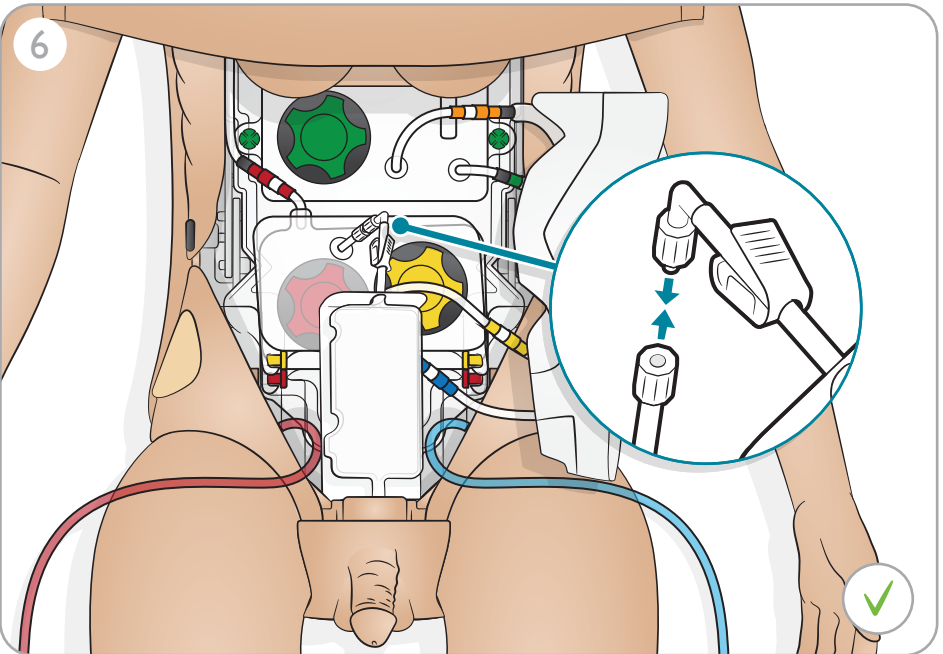

Teeth

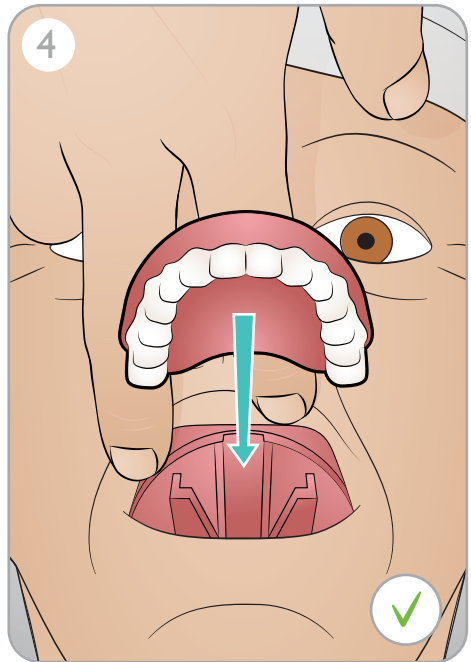
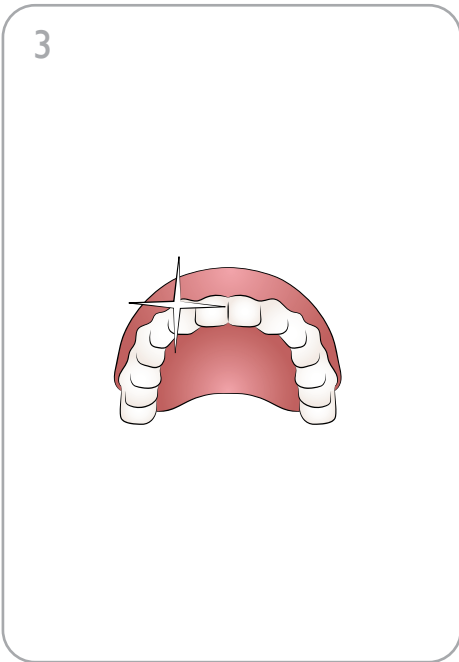
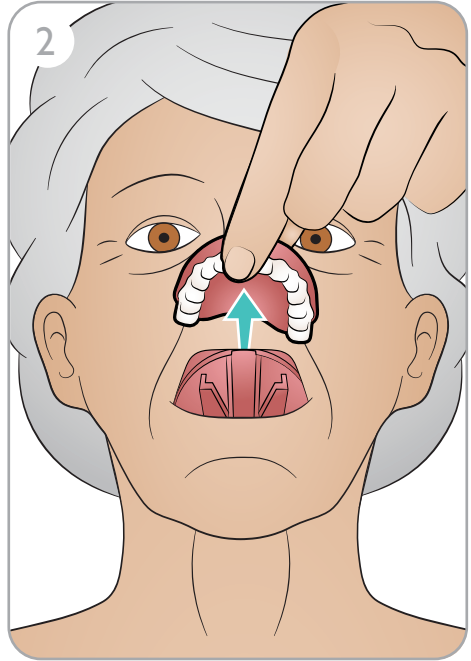
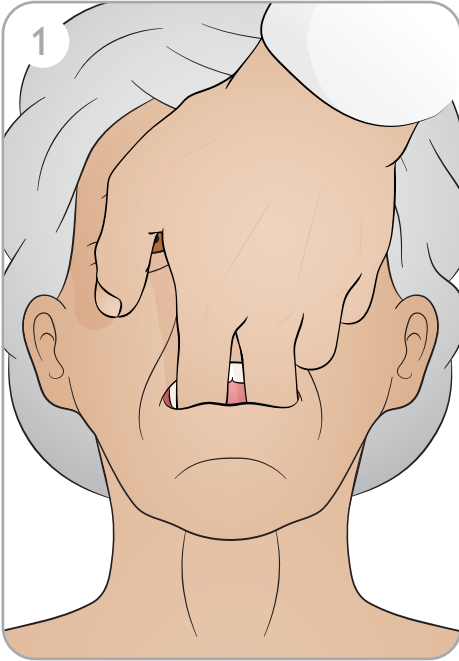

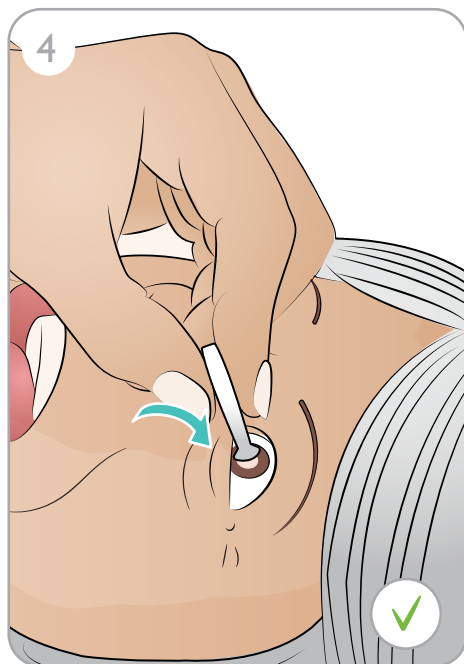
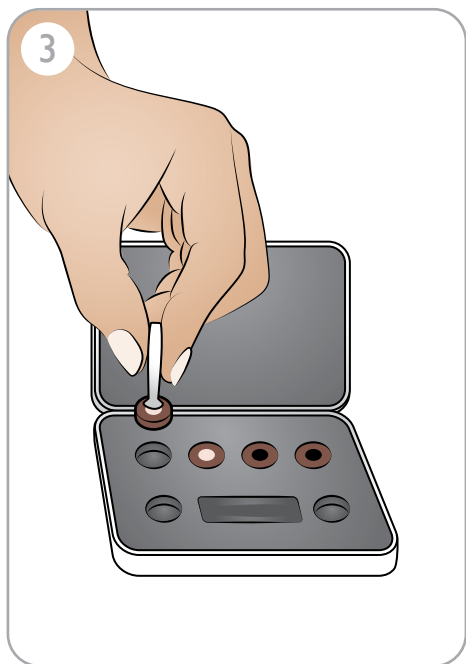
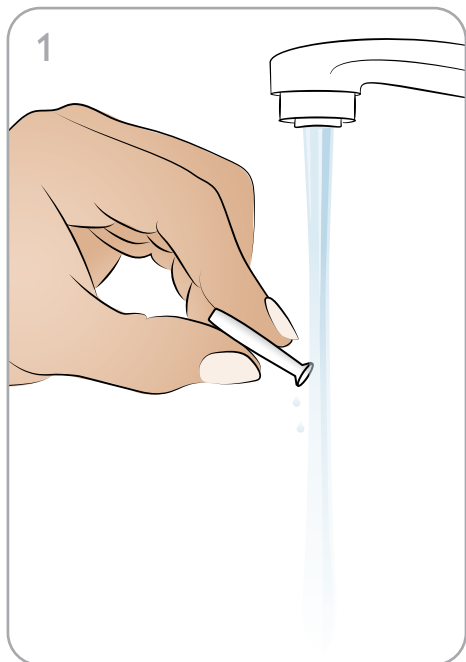

© 2021 Laerdal Medical AS. All rights reserved.

Manufacturer: Laerdal Medical AS
P.O. Box 377
Tanke Svilandsgate 30, 4002 Stavanger, Norway
T: (+47) 51 51 17 00

Printed in USA

20-17831 Rev A

www.laerdal.com



Laerdal
helping save lives