

Resusci Anne QCPR Upgrade Kit AED

Installation Guide

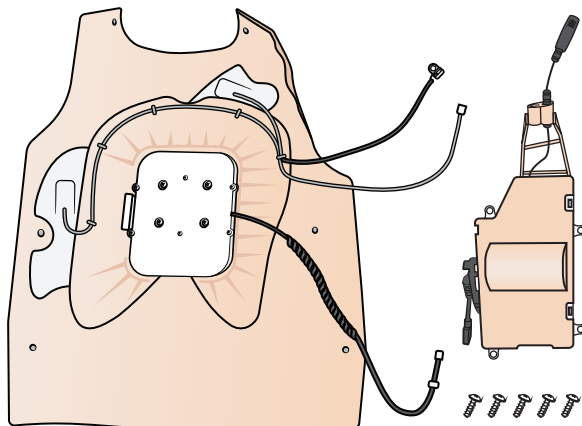

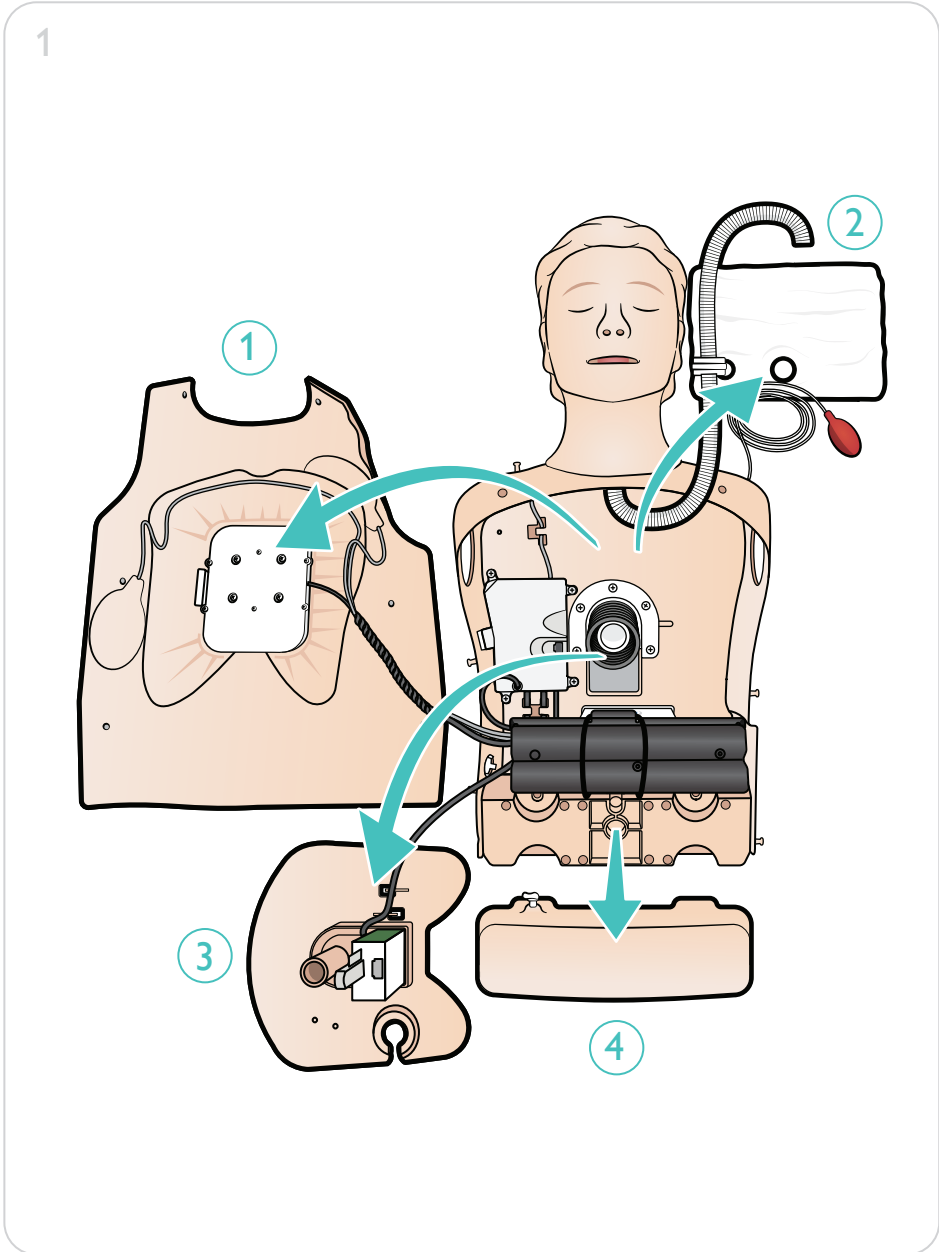

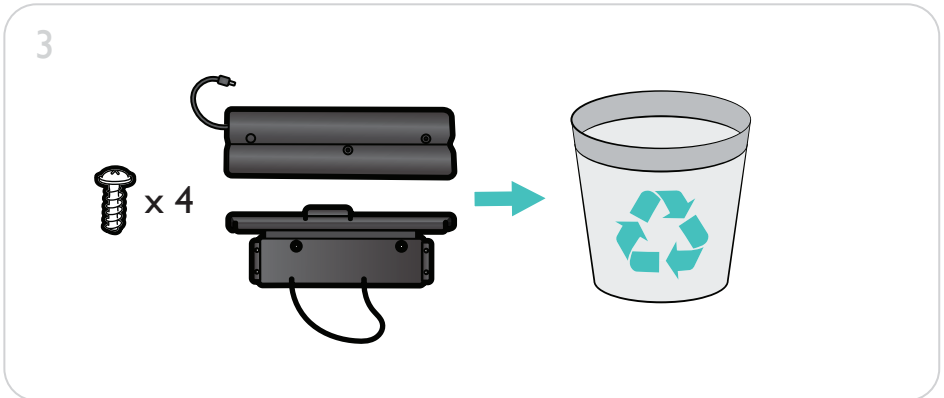
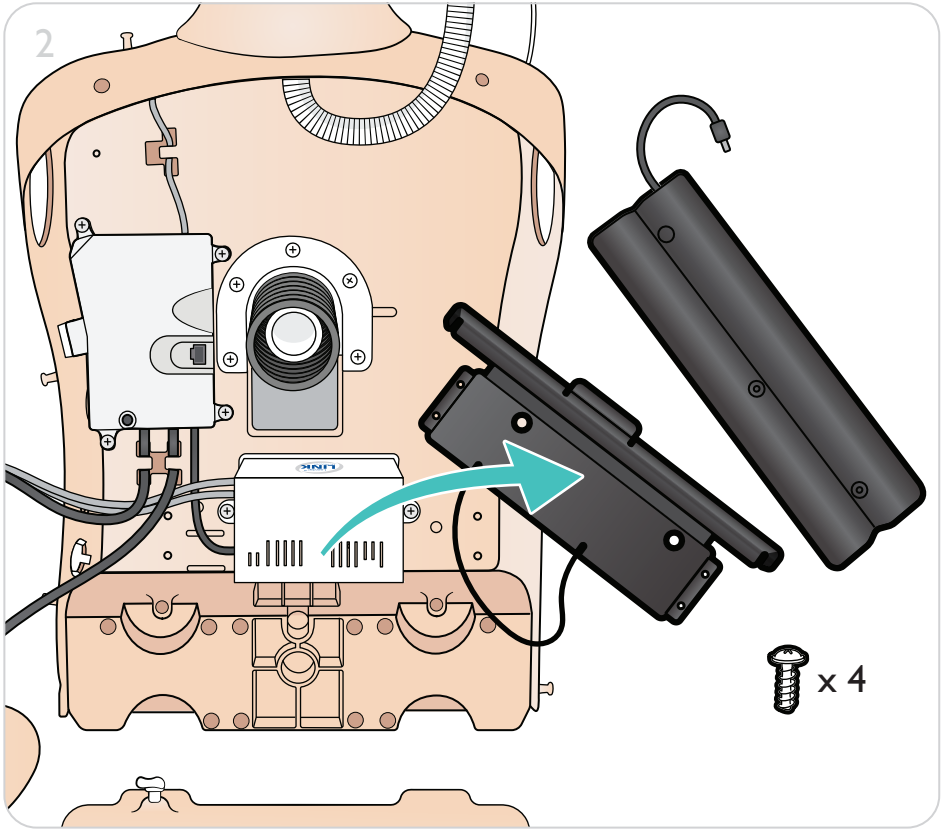

4

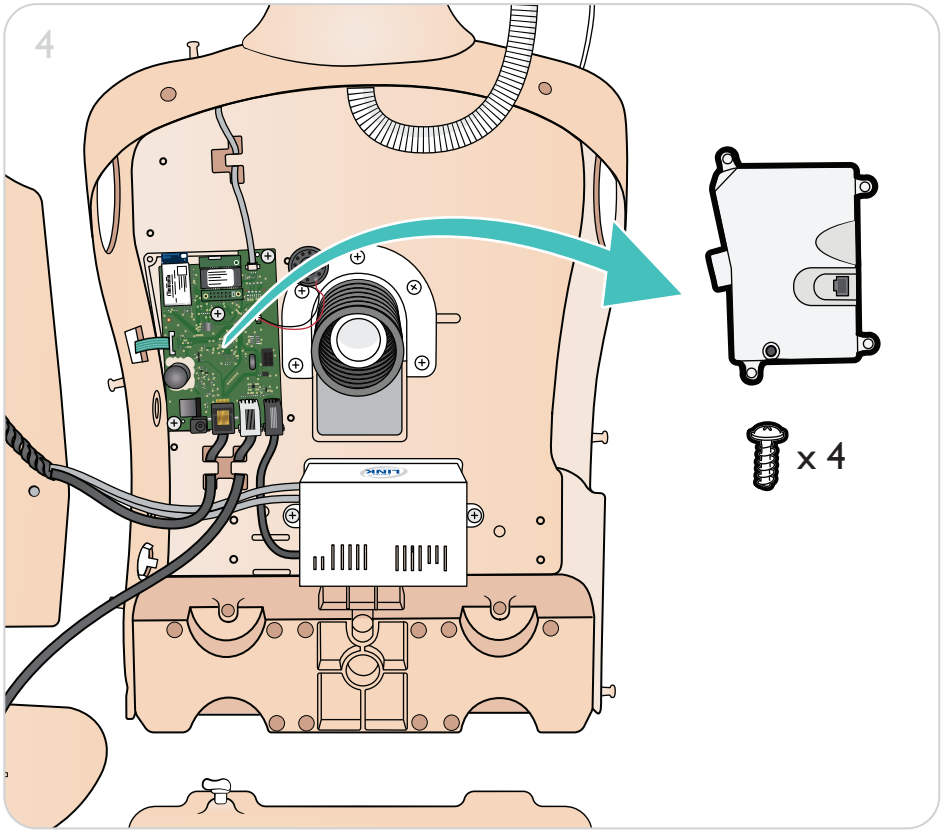

5

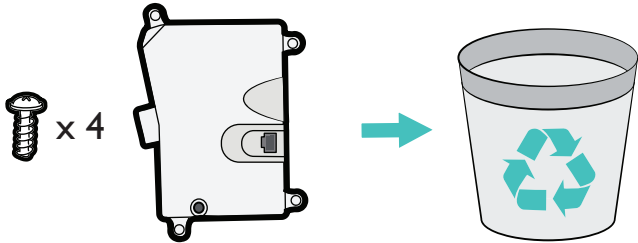

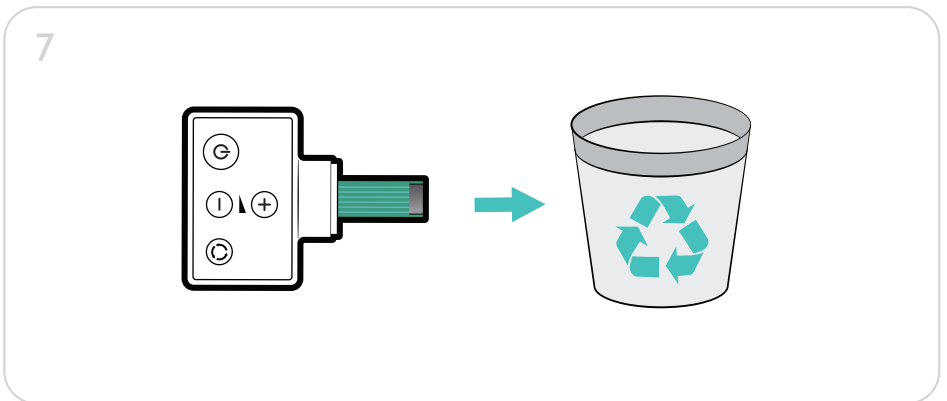
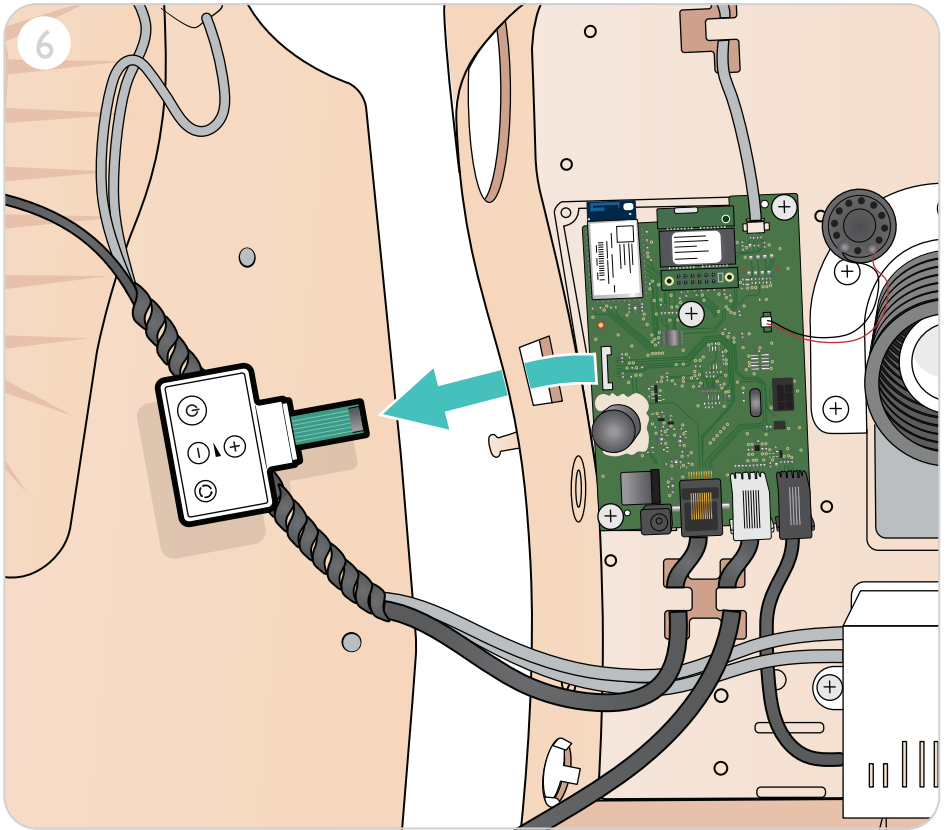

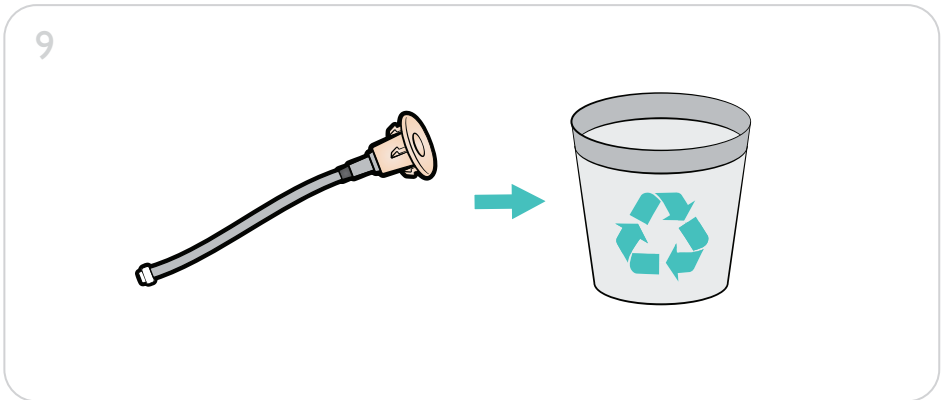
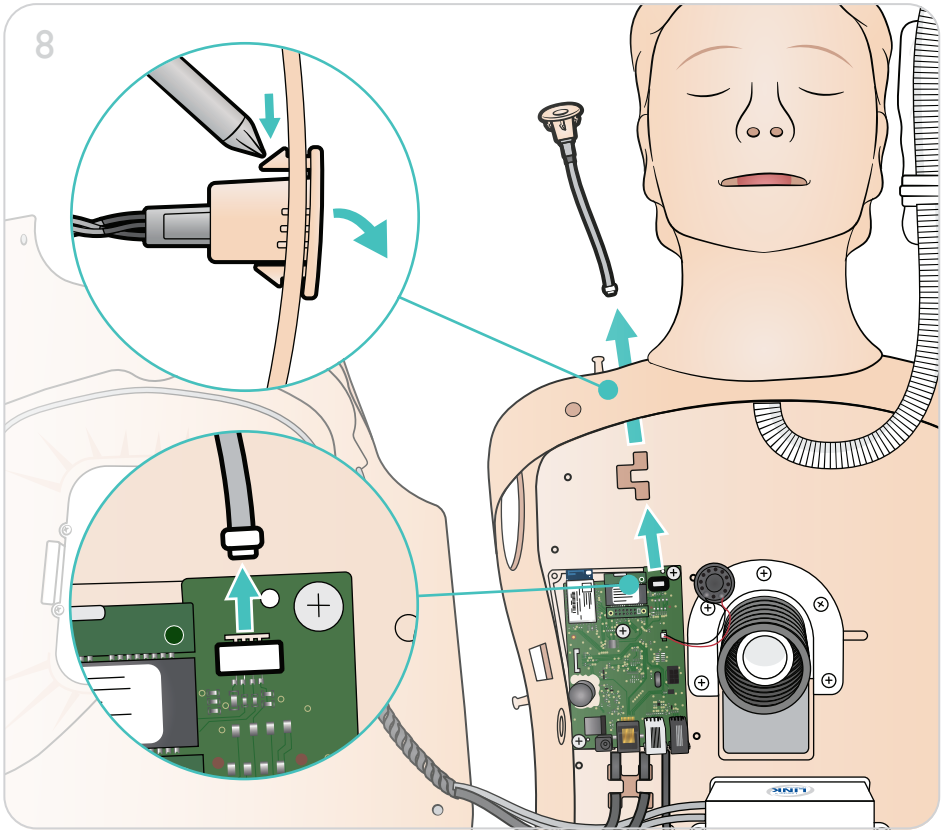

10

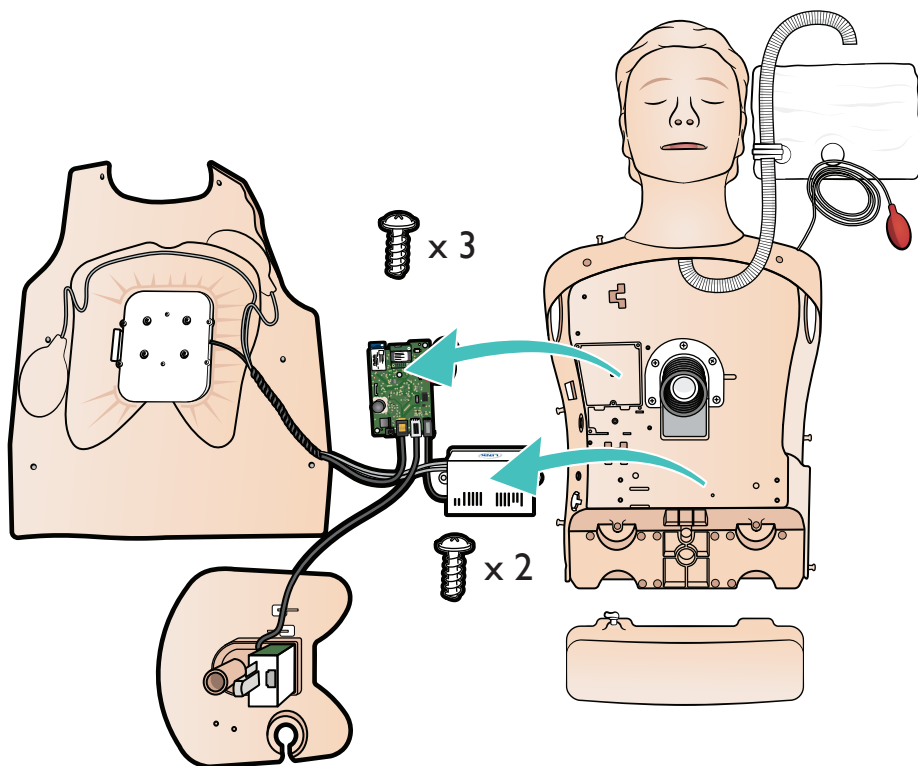

11

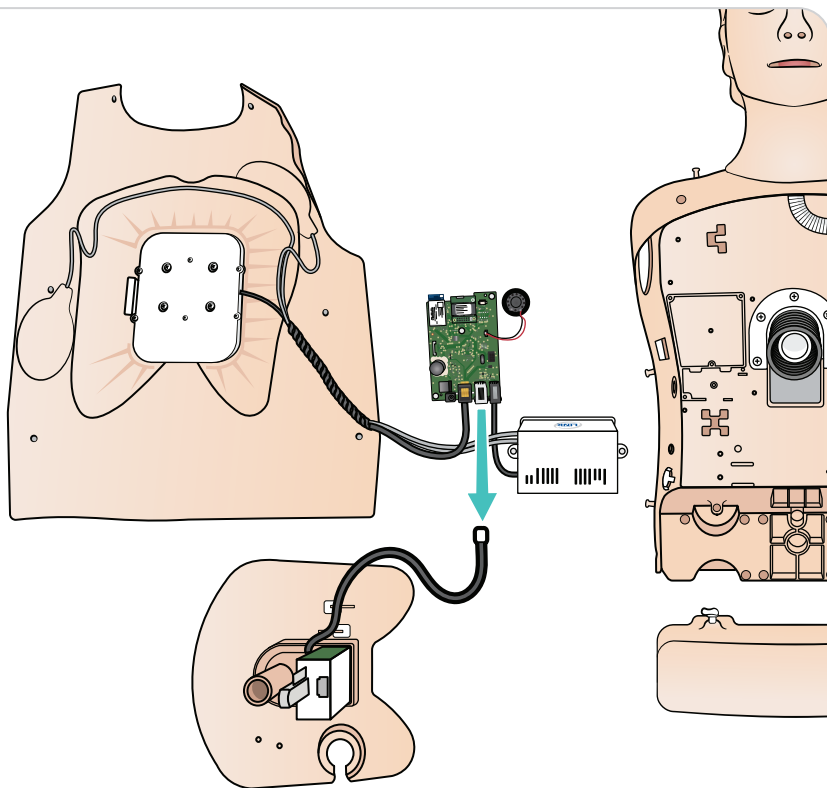

12

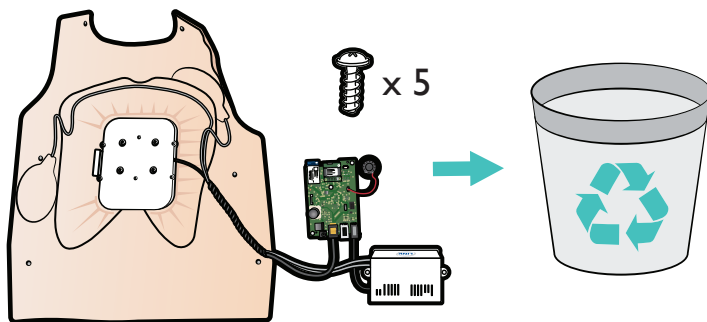

2

1

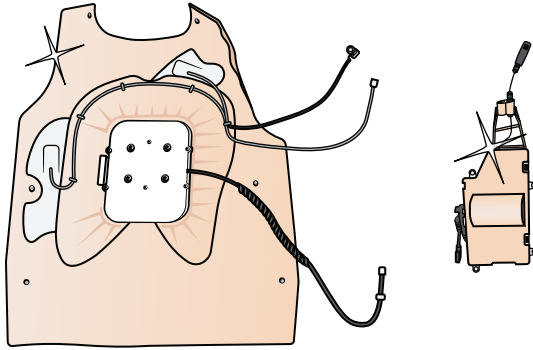

2

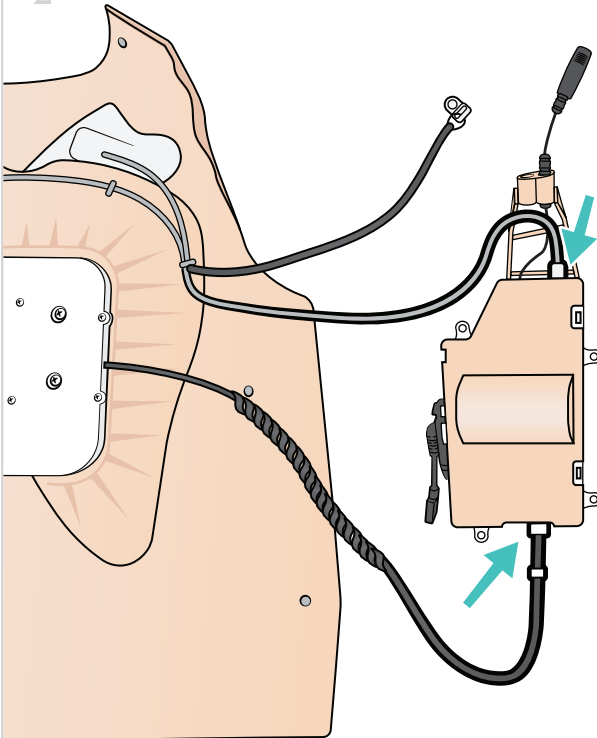

3

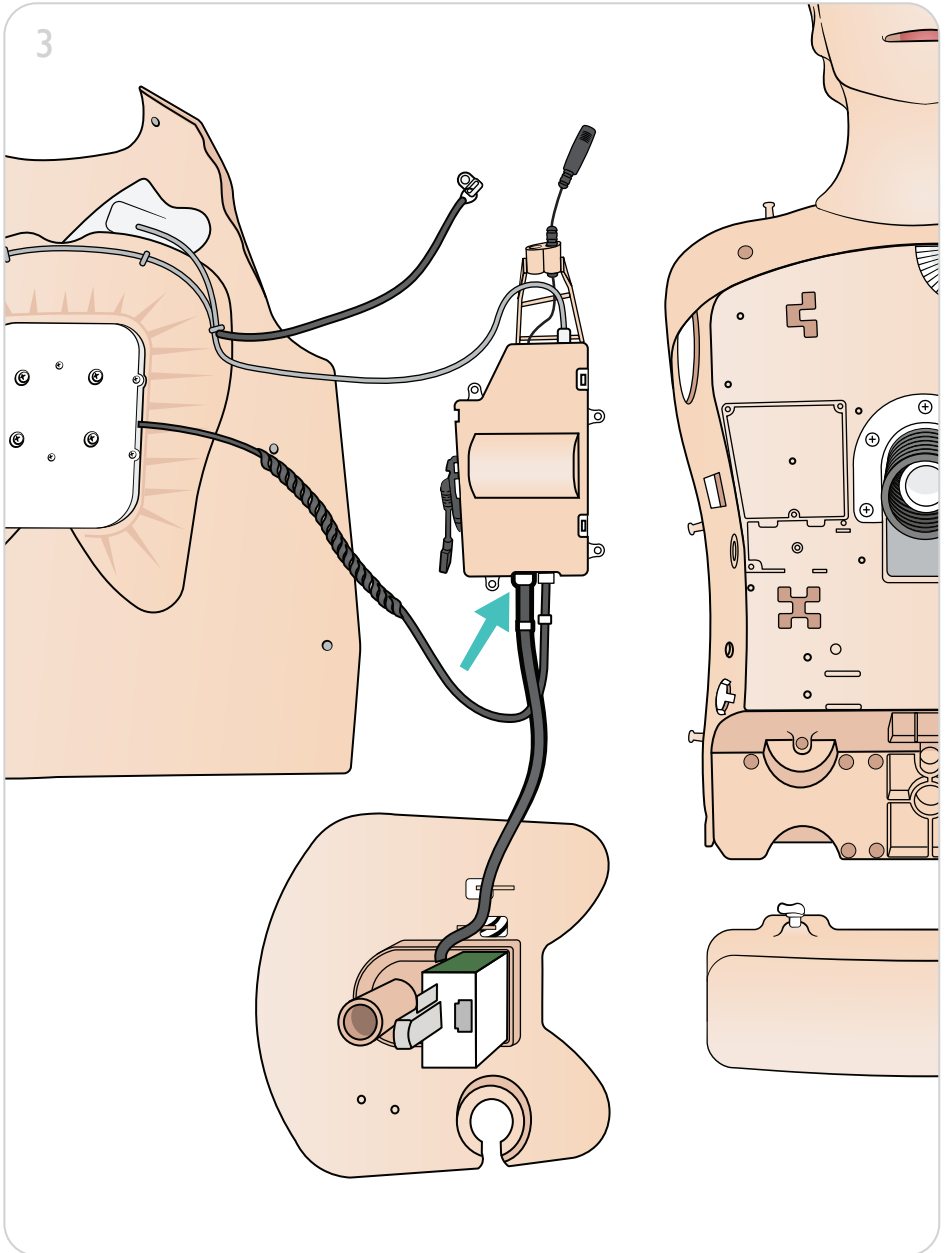

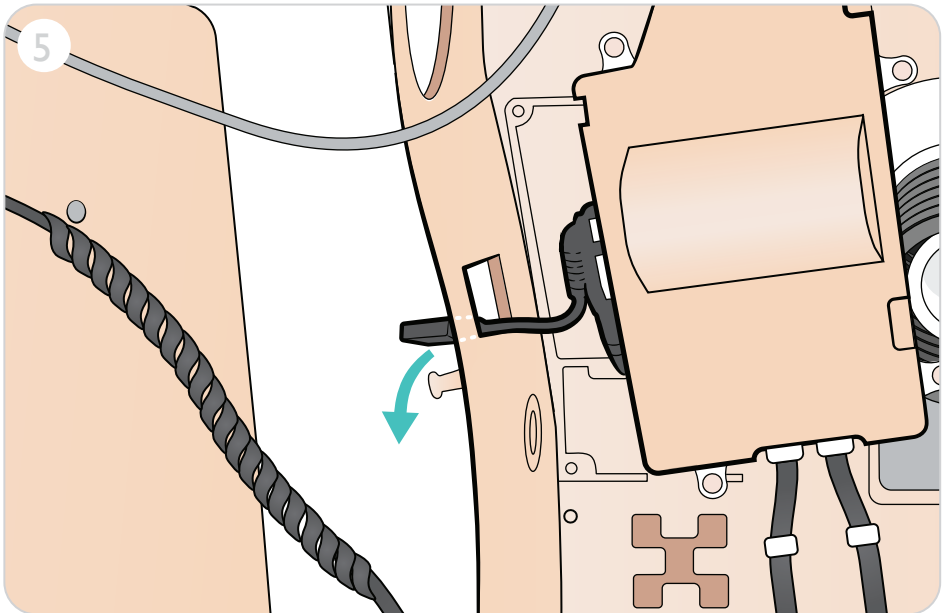
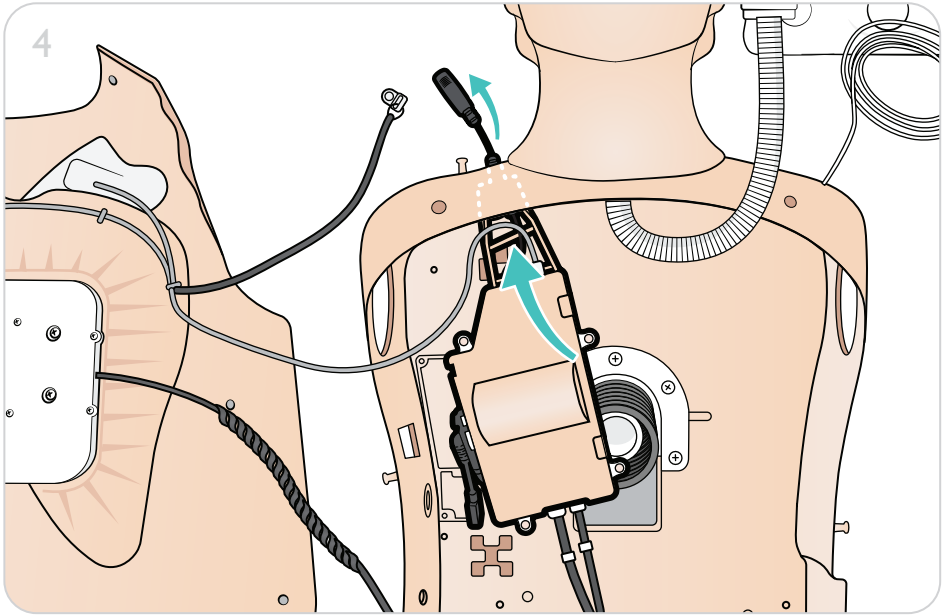

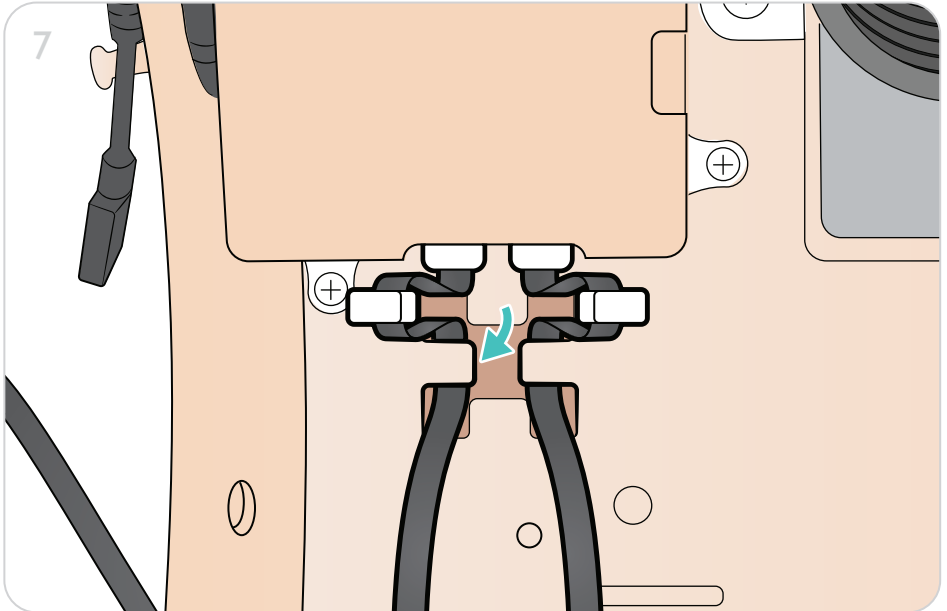
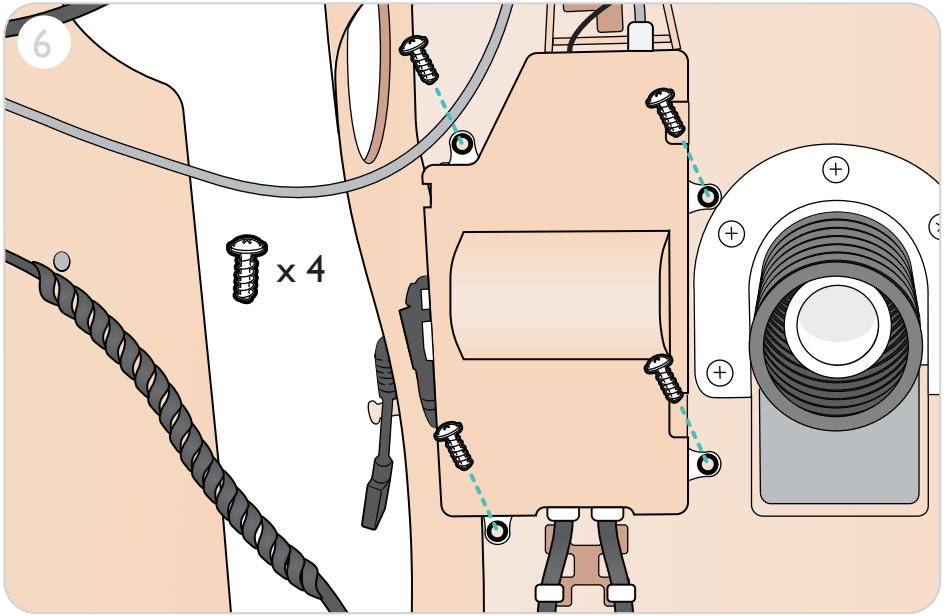

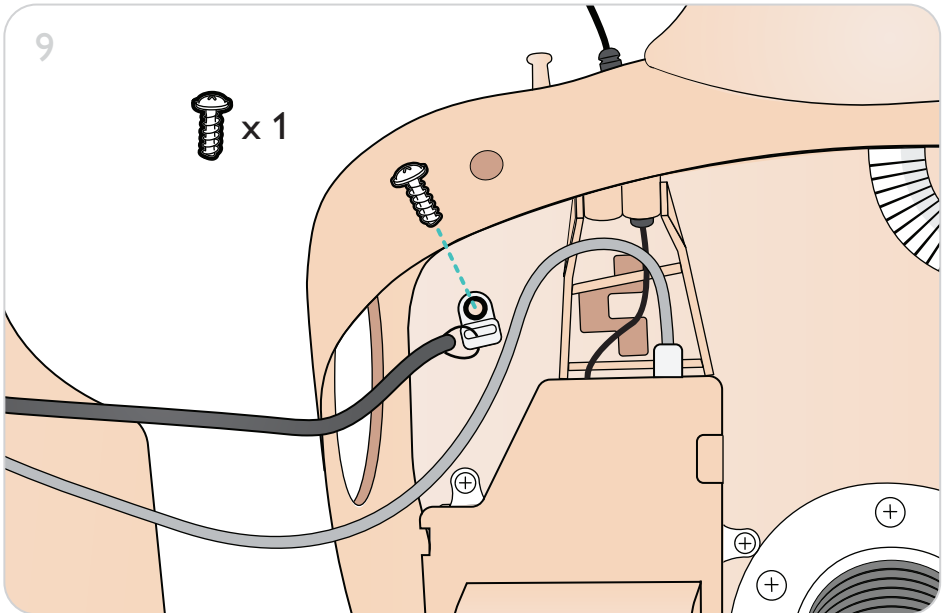
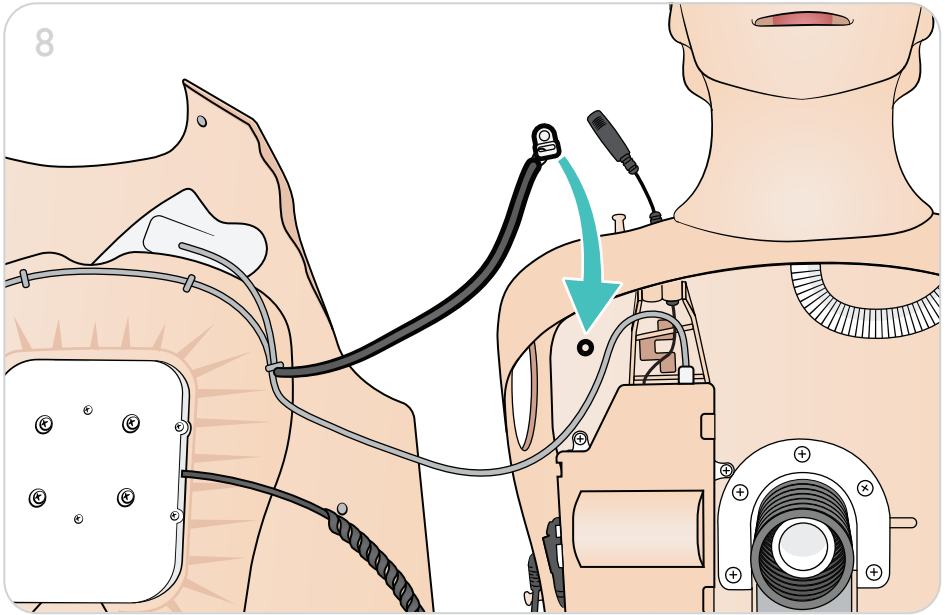

10

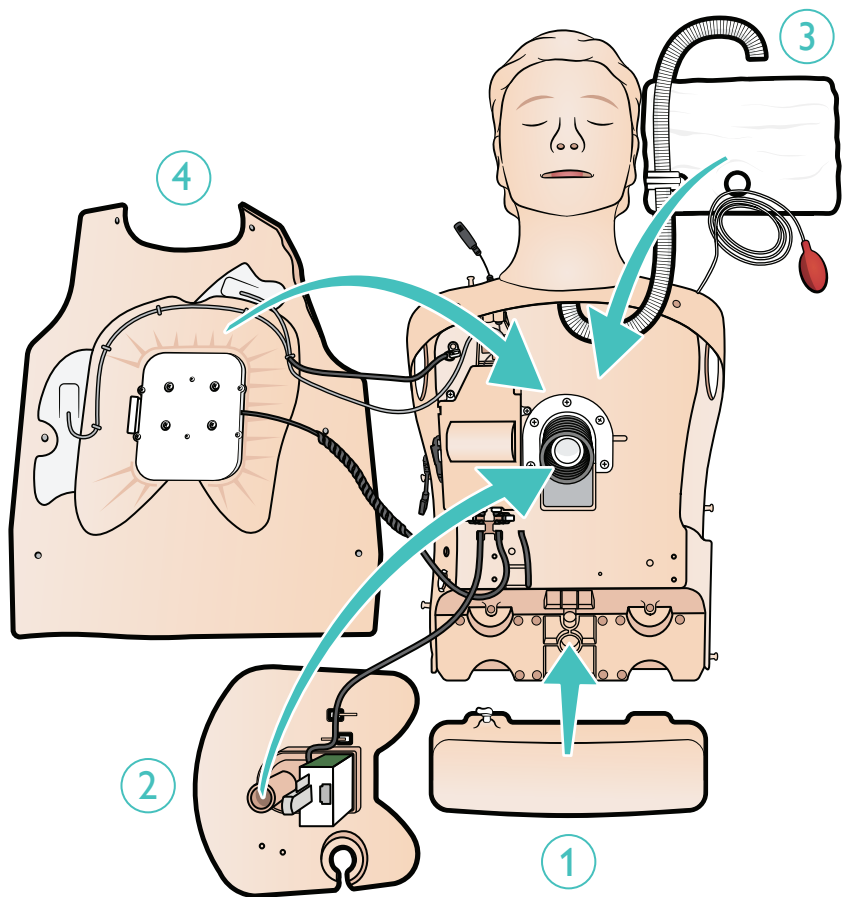

© 2018 Laerdal Medical AS. All rights reserved.

Printed in China

20-14358 Rev A

www.laerdal.com



Laerdal
helping save lives