

SimBaby

User Guide

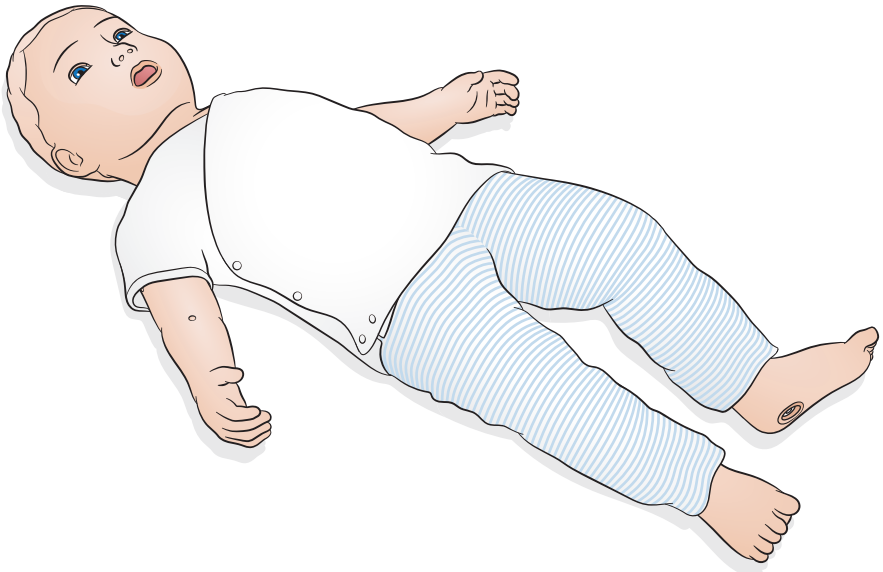

Contents

Introduction	4
Items Included	5
System Overview & Setup	6
Features	7
Airway Features	7
Breathing Features	7
Cardiovascular Features	7
Vascular Features	7
Other Features	7
Power Panel	8
Power Indicator Status	8
Charge	9
Connect	10
Connect	11
Overview Pulses and Sounds	12
Overview - Capillary Refill	13
Preparing for Simulation - IV - Fluids / Medication Infusions	14
Preparing for Simulation - IO - Fluids / Medication Infusions	15
Preparing for Simulation - Chest Drain Module	16
Preparing for Simulation - Lubrication	17
Lubricate Tools	17
Use - Intubation	18
Use - Ventilation	19
Use - QCPR	20
Use - Defibrillation and ECG Monitoring	21

Use - IV Arm	22
Use - IV Leg	23
Use - IO Leg	24
Care and Cleaning	25
General Care	25
Skin	25
Moulage	25
Maintenance - Changing the IO Leg	26
Maintenance - Changing the IV Port	27
Maintenance - Chest Drain Module	28
Maintenance - Needle Decompression Module	29

Introduction

SimBaby is a tetherless simulator designed to help healthcare providers effectively recognize and respond to critically ill pediatric patients. The SimBaby simulator represents a 9-month-old pediatric patient and provides a highly realistic manikin that meets specific learning objectives focusing on initial assessment and treatment.

Read the enclosed Important Product Information booklet before use.
Refer to the Laerdal Global Warranty for terms and conditions.

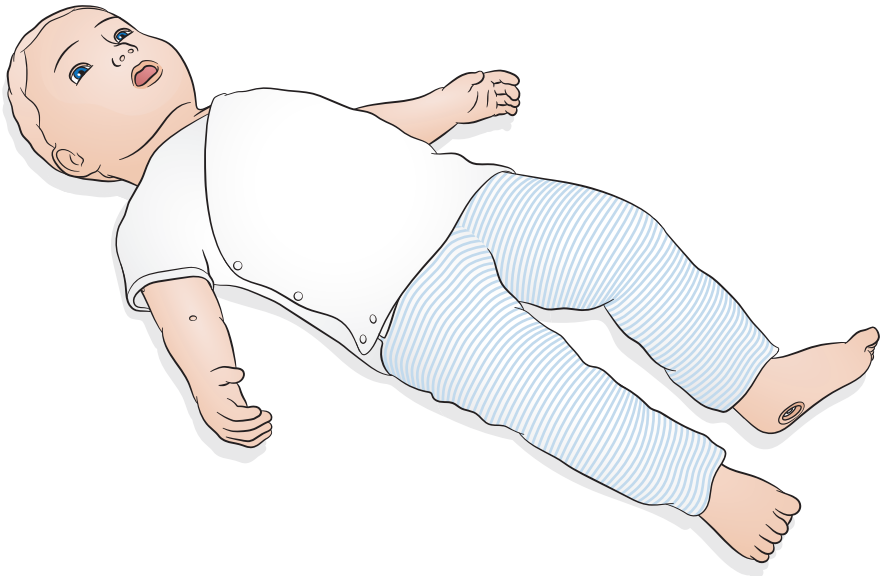

Visit www.laerdal.com to download SimPad PLUS User Guide, software updates and other product information.

Items Included

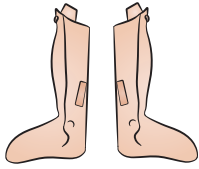

x 2

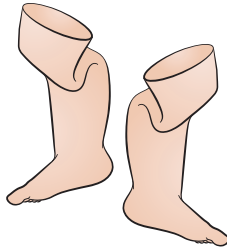

x 5

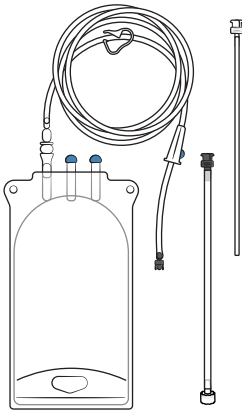

x 2

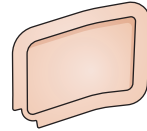
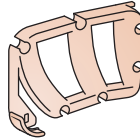

x 5



x 20

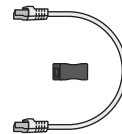
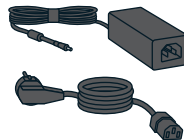
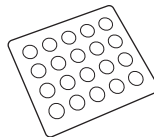
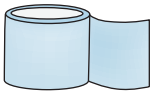

Items included may vary in appearance and are subject to change.

System Overview & Setup

SimBaby is operated and controlled by LLEAP or SimPad PLUS. LLEAP is the instructor's application found in Laerdal Simulation Home. SimPad PLUS is a wireless tablet. Both can be run in Automatic Mode, with pre-programmed scenarios, or Manual Mode. When using with either LLEAP or SimPad PLUS vital signs can be displayed on the optional patient monitor.

For further information about SimPad PLUS and to access all product downloads visit www.laerdal.com/SimPadPlus



LLEAP



SimPad PLUS

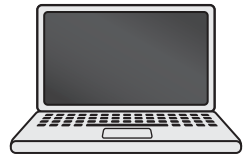

Patient Monitor

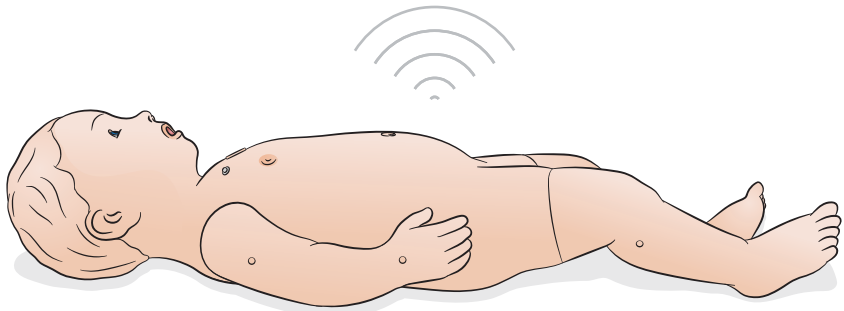

Airway Features

- Anatomically accurate, realistic airway
- Bag-Valve-Mask ventilation
- Intubation (Orotracheal and nasotracheal, Fiberoptic, Right mainstem)
- Insertion (LMA, Endotracheal tube, Gastric Tube)
- Sellick Maneuver
- Variable lung compliance and airway resistance
- Tongue edema
- Laryngospasm
- Pharyngeal swelling (partial and complete)
- Stomach distention

Breathing Features

- Spontaneous breathing with variable rate, depth and regularity
- Bilateral and unilateral chest rise and fall
- Normal and abnormal breath sounds
- Oxygen saturation on simulated Patient Monitor
- Breathing pattern (normal, retraction, see-saw)
- Pneumothorax
- Unilateral thoracentesis midclavicular
- Unilateral chest tube insertion midaxillary

Cardiovascular Features

- ECG monitoring and library
- QCPR
- Blood pressure (BP)
- Pulse strength variable with BP
- Pulses (bilateral brachial and bilateral femoral)
- Live defibrillation using ShockLink

Vascular Features

- Unilateral IV access antecubital fossae, dorsum of the hand
- Bilateral IV access long saphenous vein
- Bilateral tibial IO insertion
- IV bolus and infusion administration



Other Features

- Eyes - open, closed, and 50%
- Normal, blown and constricted pupils
- Capillary refill (Left palm, proximal sternum)
- Fontanelle (normal or bulging)
- Seizure - head, eyes and arms
- Sounds - vocal, lung, heart
- Liver palpation
- Cyanosis
- Arm movement and tone

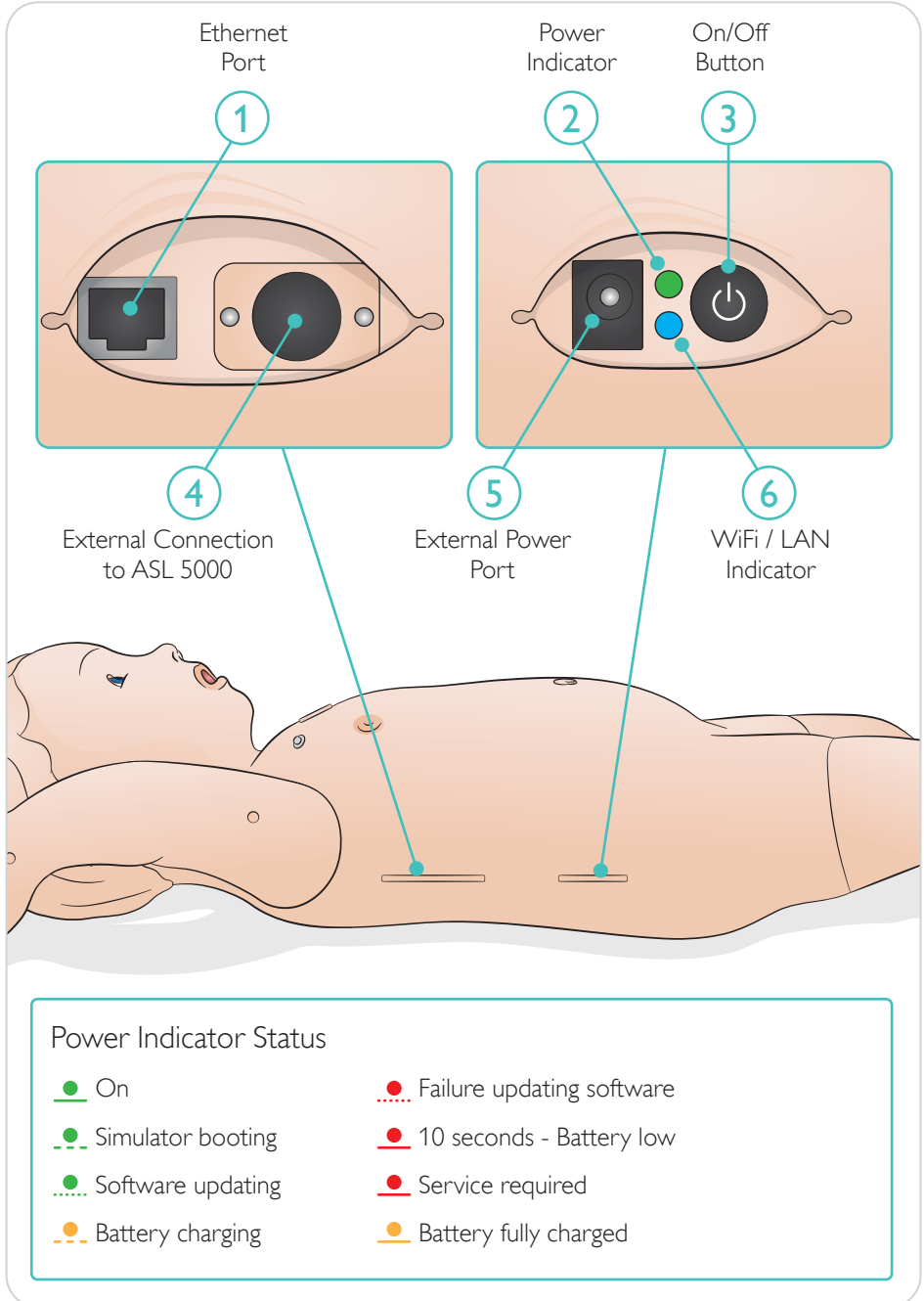
Power Panel



Fully charge the battery before first use.

-  Battery charging
-  Battery fully charged
-  10 seconds - Battery low

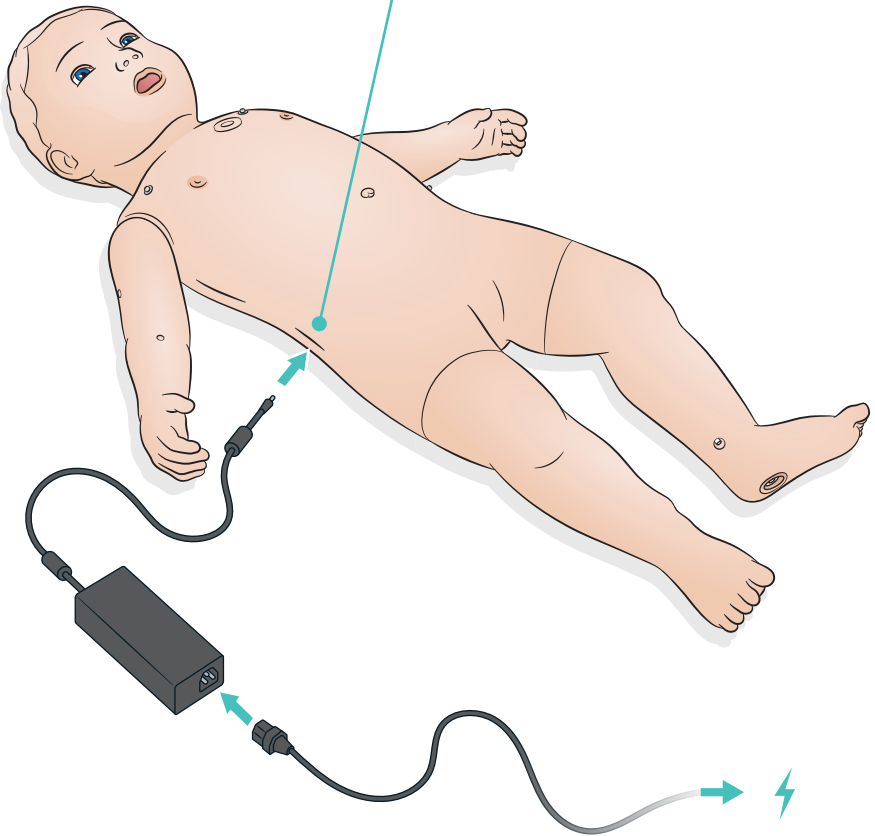
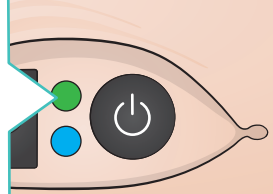

Connect

Connect to LLEAP or SimPad PLUS with WiFi.

- WiFi enabled
- WiFi connected to device
- No connection - Configure Network with Ethernet cable

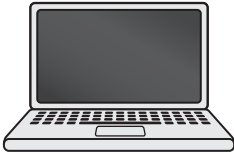
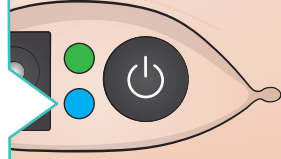

LLEAP



SimPad PLUS

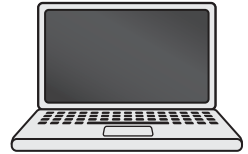

Patient Monitor

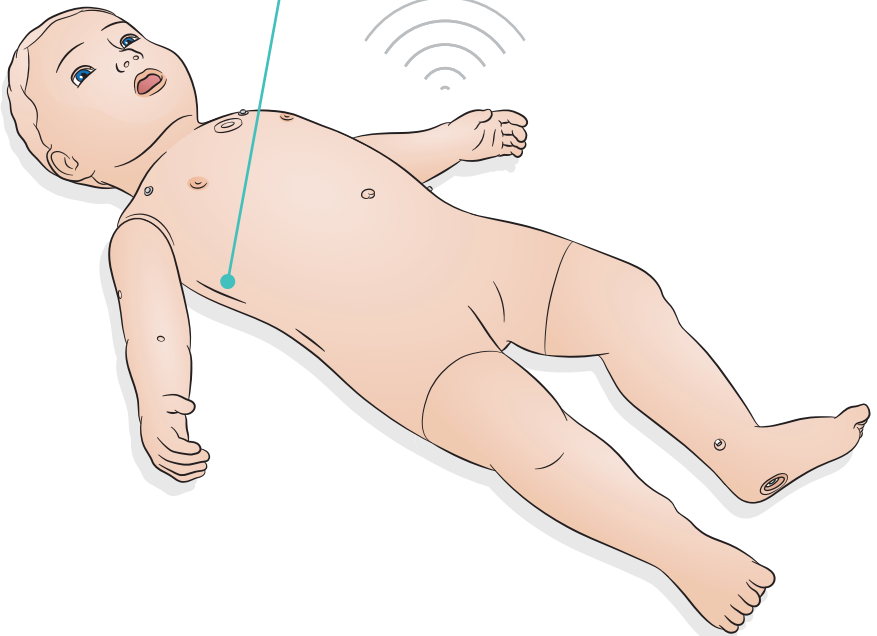



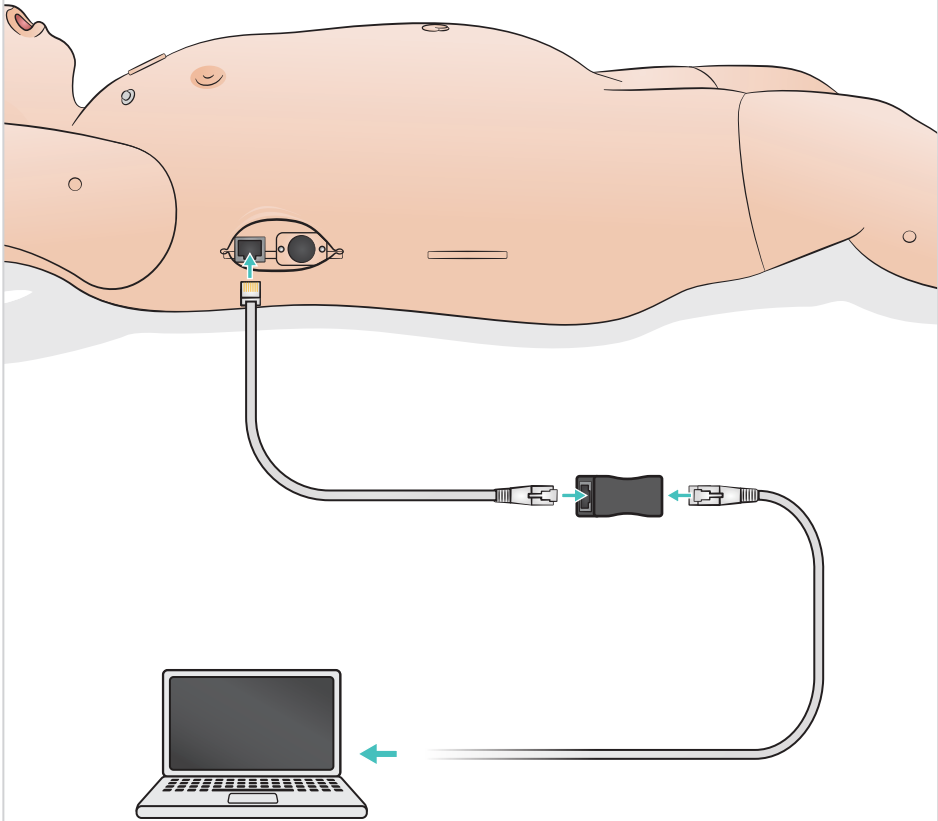

Connect SimBaby with LAN cable to perform software updates, or when WiFi is not available.



Overview Pulses and Sounds

Pulses and sounds are controlled in SimPad PLUS or LLEAP.

-  Pulses
-  Vocal Sounds
-  Lung Sounds
-  Heart Sounds

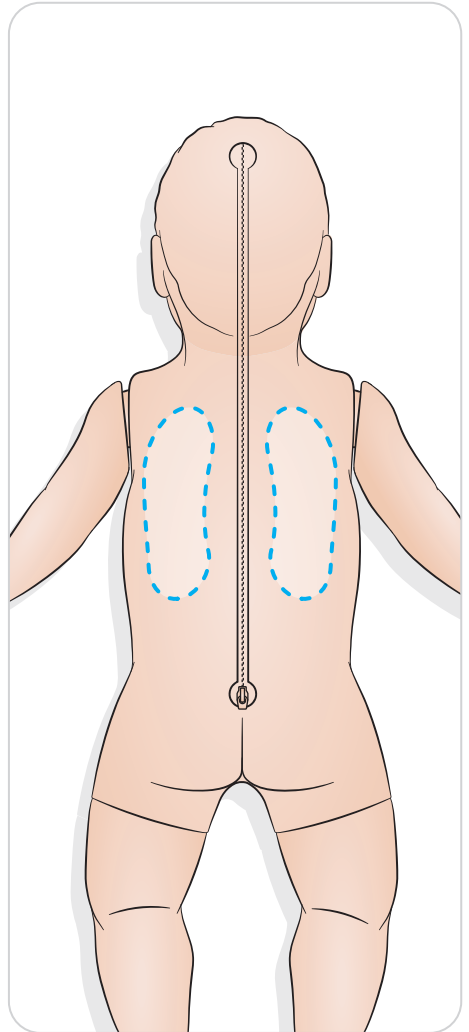
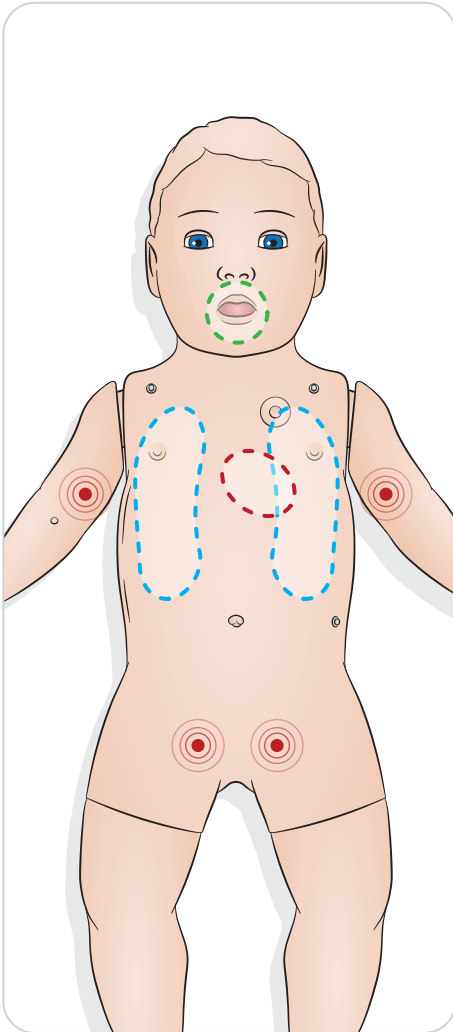

Overview - Capillary Refill

Capillary refill sensors are located under the skin on the left palm and on the proximal sternum. Press and hold to activate. Capillary refill time can be controlled in SimPad PLUS or LLEAP.

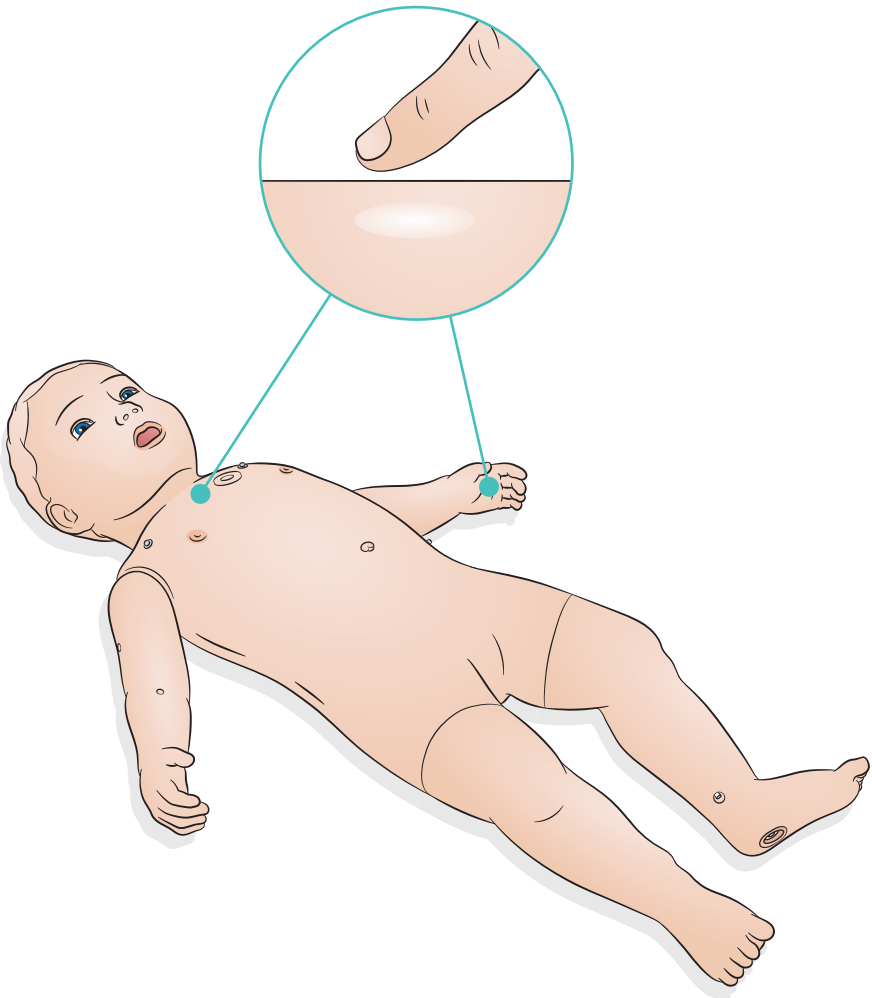

Preparing for Simulation - IV - Fluids / Medication Infusions

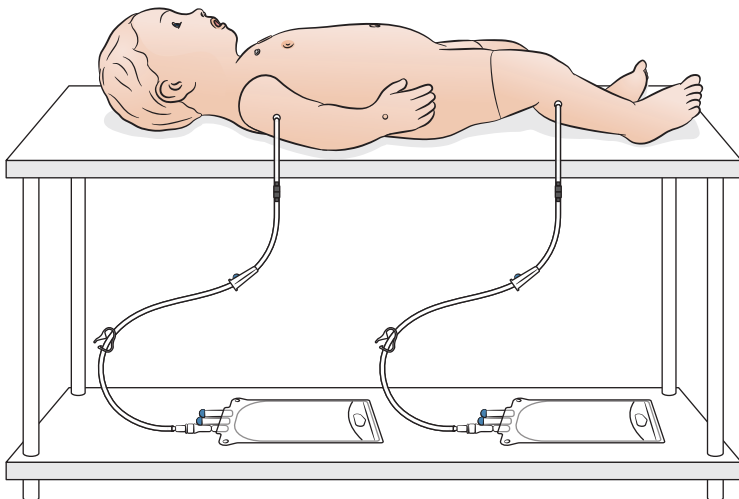
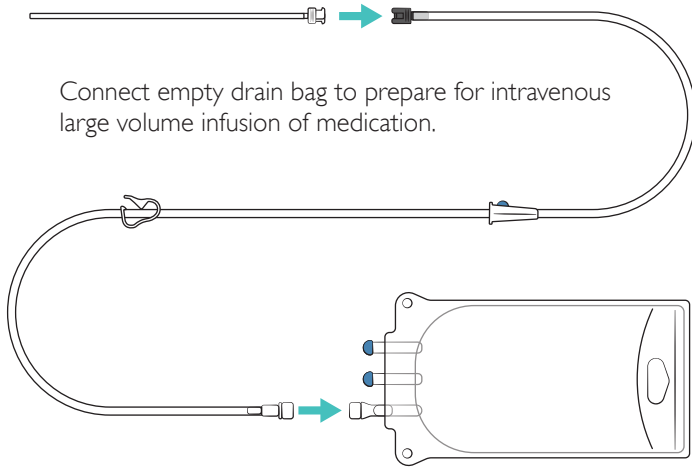

Preparing for Simulation - IO - Fluids / Medication Infusions

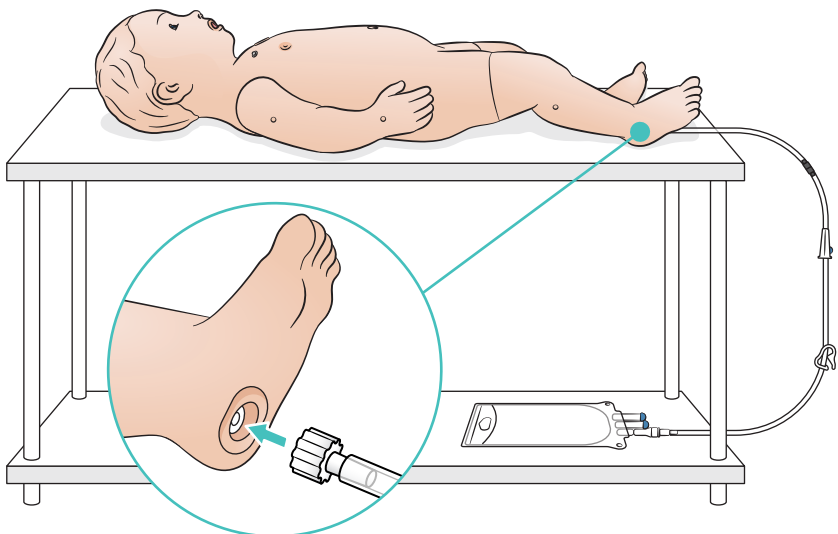
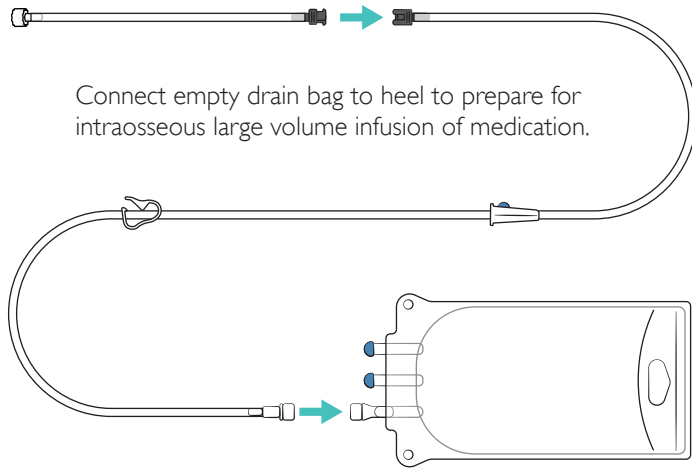

Preparing for Simulation - Chest Drain Module

Replace tape after each use. Use standard surgical tape, do not use silicone tape. Add additional layers of tape to increase resistance as required.

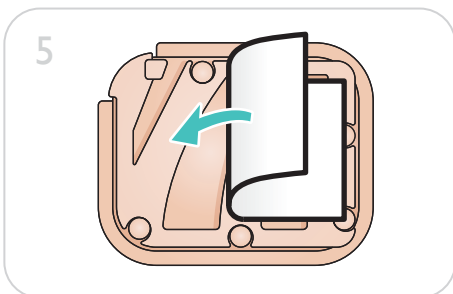
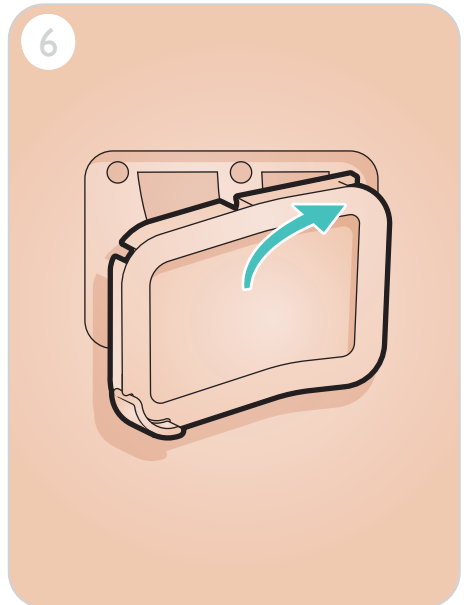
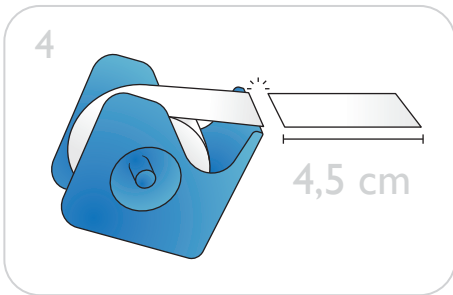
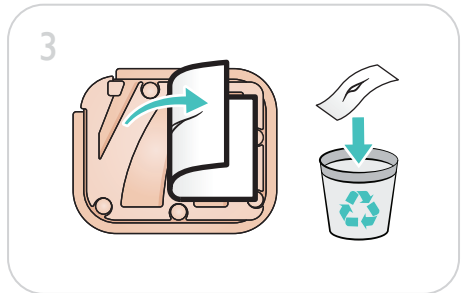
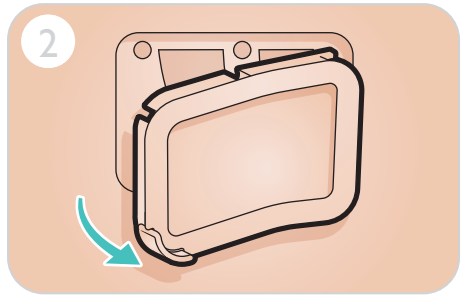
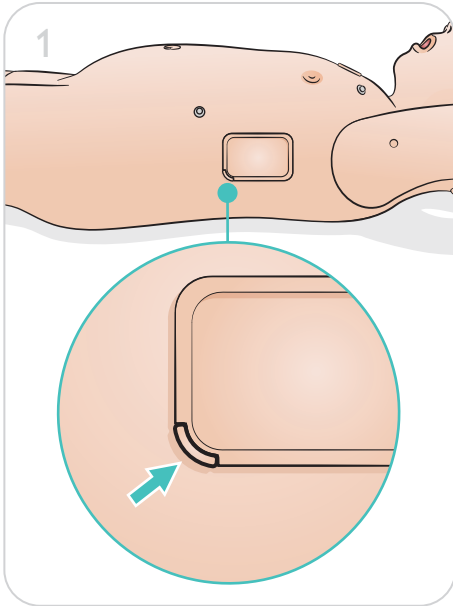

Preparing for Simulation - Lubrication

Lubricate Tools

Lubricate laryngoscope blade and tubes prior to insertion into the airway.

 Caution

Non-lubricated instruments and tubes may cause damage to the airway. Only use Silicone Lubricant provided by Laerdal Medical.

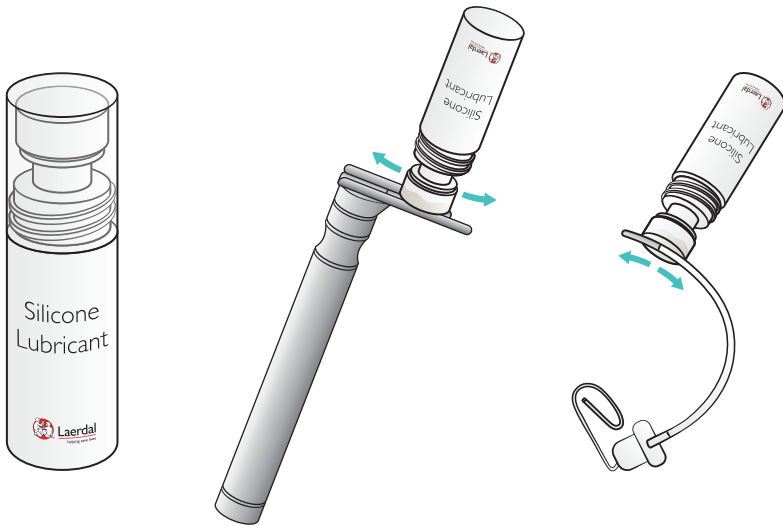

Use - Intubation

Perform nasal or oral intubation.

Recommended adjunct sizes:

- ET Tube: 3.5mm (cuffed and uncuffed) / 4.0mm (uncuffed) - to mark 12
- LMA: Size 1.5
- Laryngoscope: Miller Blade Size 0 or 1
- OG / NG tube: 8 Fr
- Suction catheter: 8 Fr

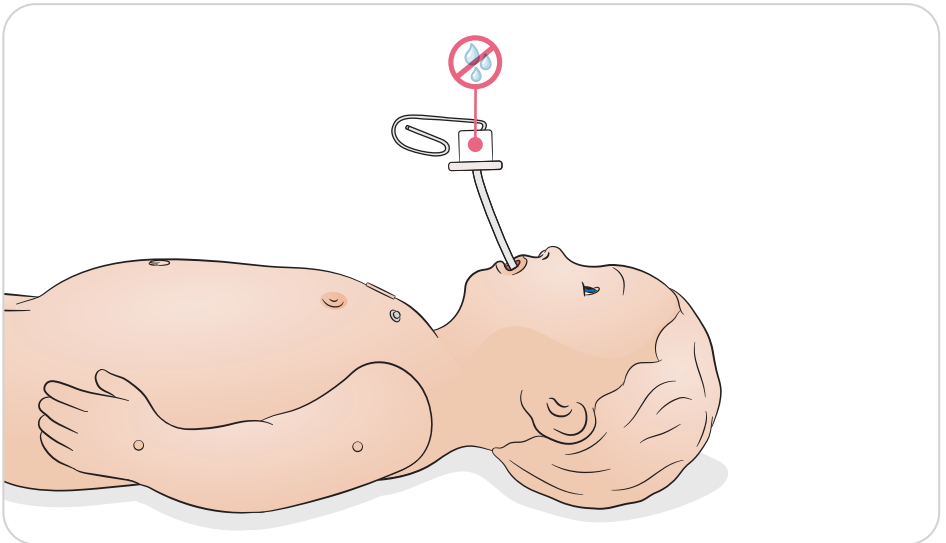
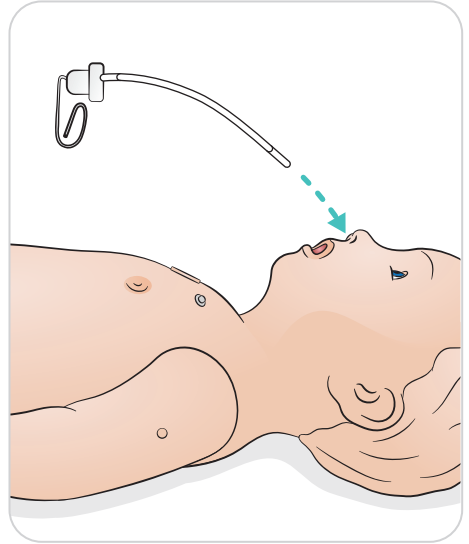
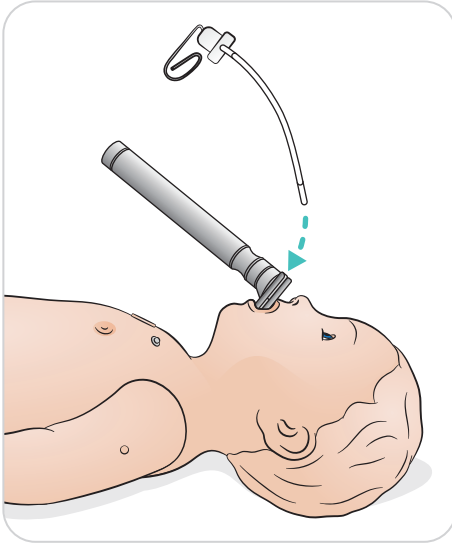

Use - Ventilation

Perform ventilations with visual chest rise, and get feedback in SimPad PLUS or LLEAP. Stomach distention and tongue fallback features are controlled in SimPad PLUS or LLEAP.

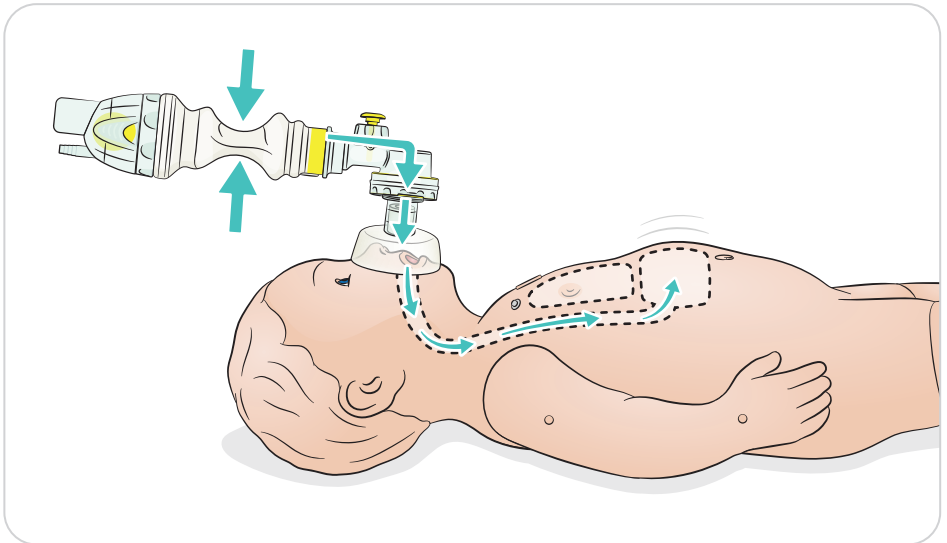
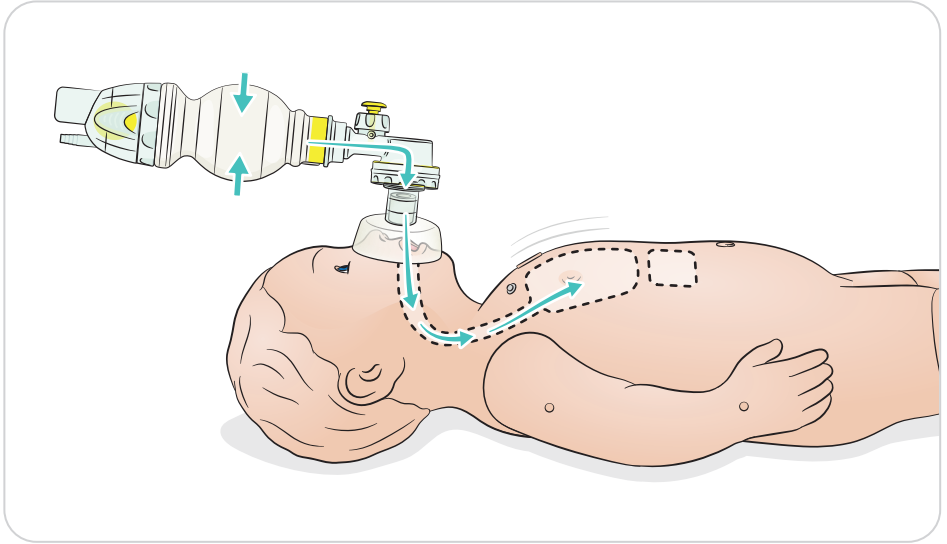

Use - QCPR

QCPR

- Compliant with 2015 AHA or ERC guidelines
- Compressions generate palpable pulses, blood pressure wave form and ECG artifacts
- Realistic compression depth and resistance
- Detection of depth, release and frequency of compressions
- QCPR is monitored with feedback via LLEAP and SimPad PLUS

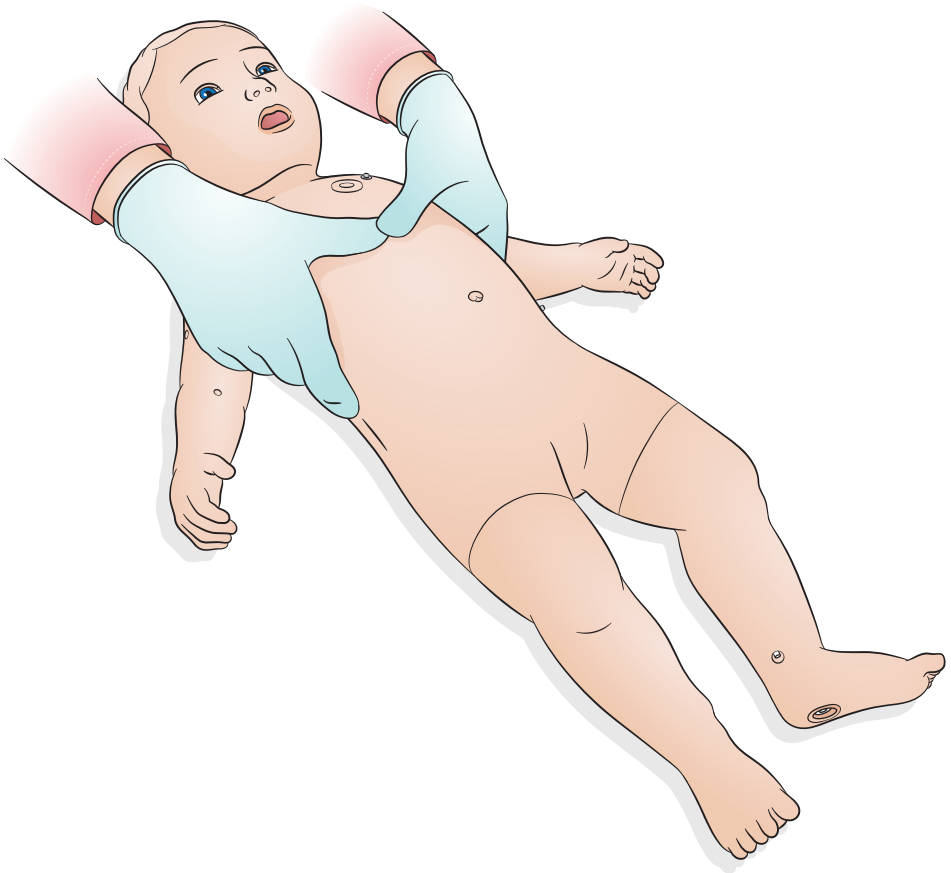

Use - Defibrillation and ECG Monitoring

ShockLink (sold separately) enables connection between SimBaby and a live defibrillator allowing the following procedures to be performed:

- Defibrillation
- Synchronised cardioversion
- External pacing with or without capture

Place ShockLink training pads in the anterior and posterior positions.

 Warning

Only defibrillate using ShockLink as described in ShockLink instructions.

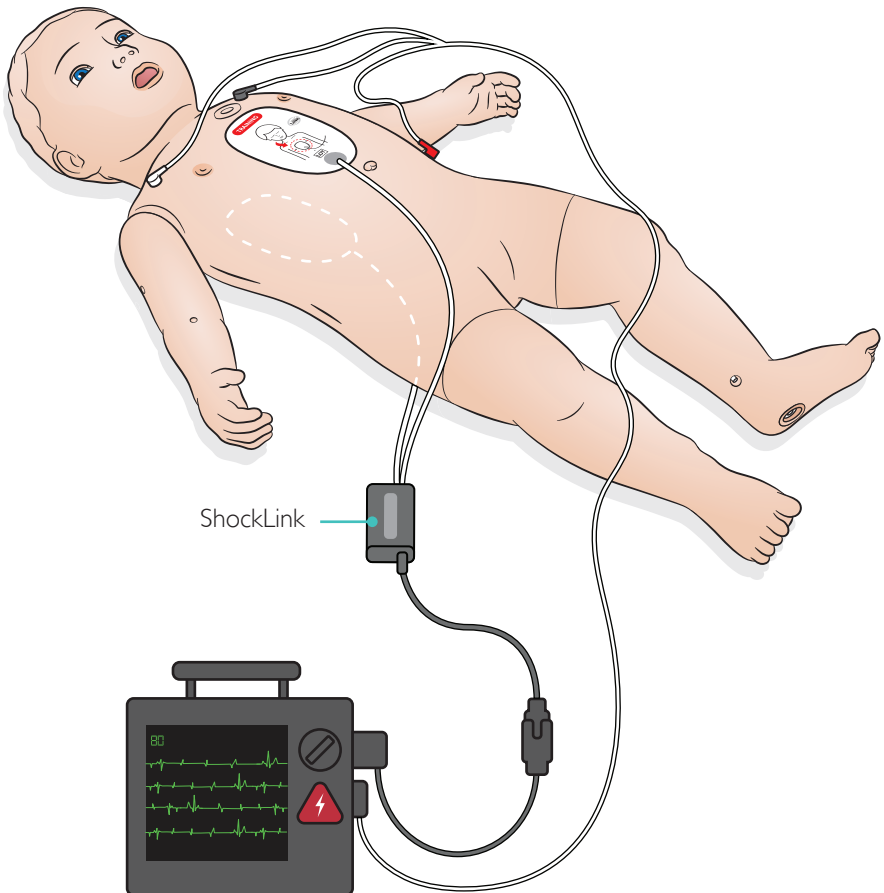

Use - IV Arm

The IV arm supports simulation of IV drug administration, IV insertion, infusion, and bolus into peripheral veins of forearm, antecubital fossae, and dorsum of the hand.

 Note

Do not store the simulator with fluid in the IV Arm/Leg System. Use a syringe to flush remains of any injected water from the tubing and components prior to storage.

Recommended needle size: 22 - 24 G

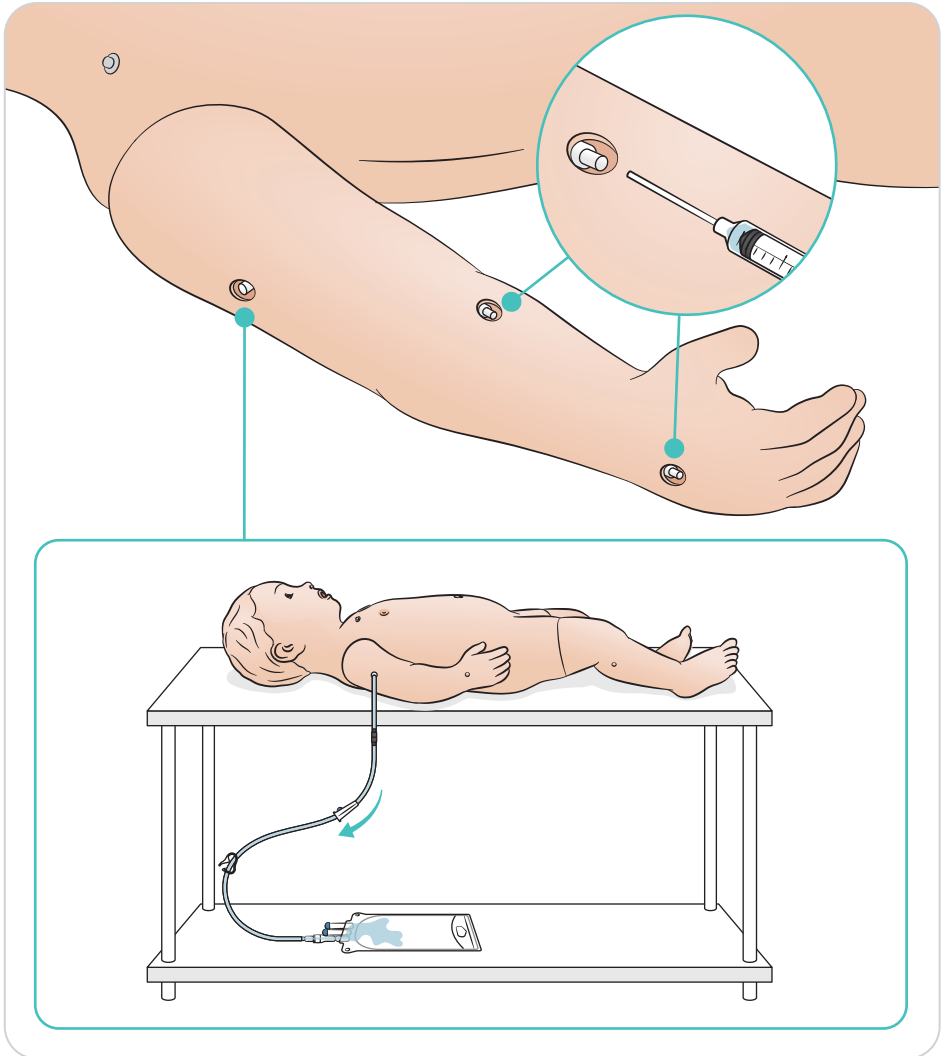

The IV leg supports simulation of IV drug administration, IV insertion, infusion, and bolus into Long Saphenous.

Recommended needle size: 22 - 24 G

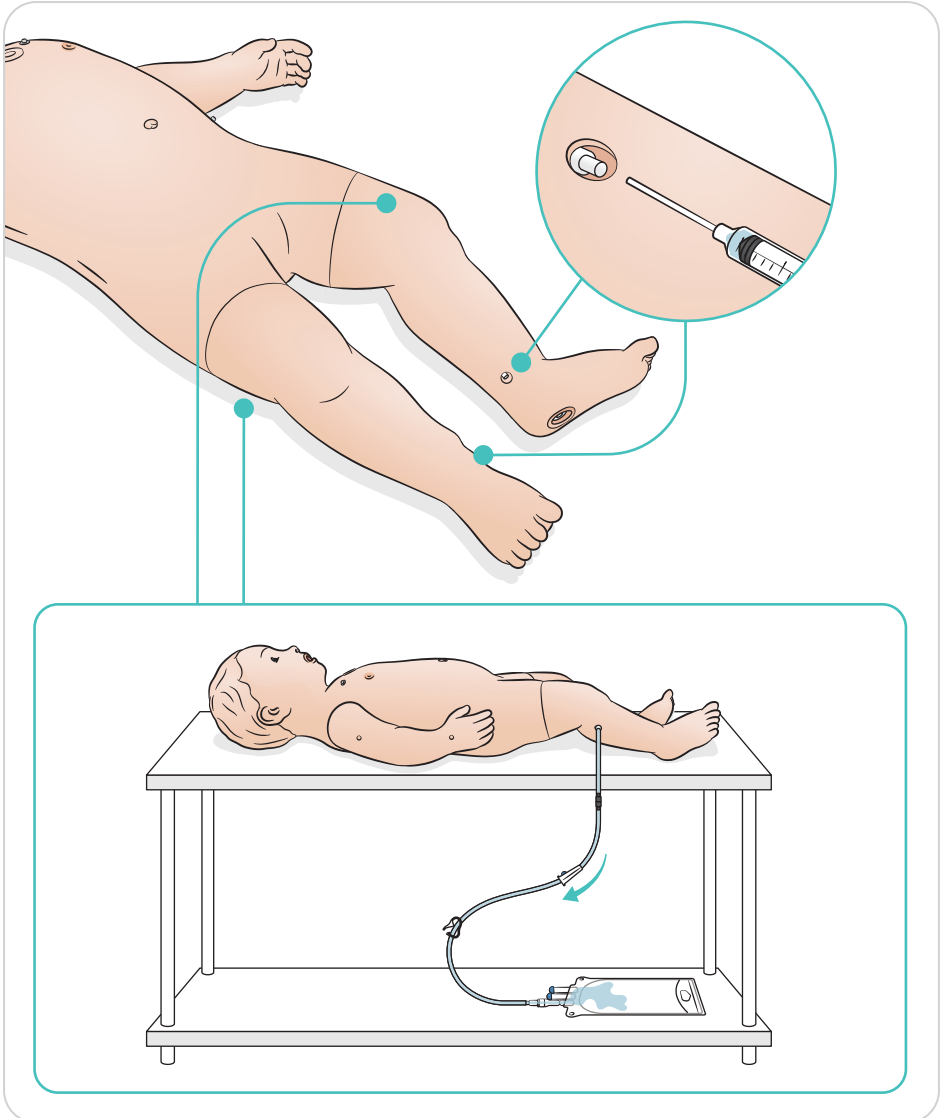

Use - IO Leg

The IO leg supports simulation of intraosseous infusion.

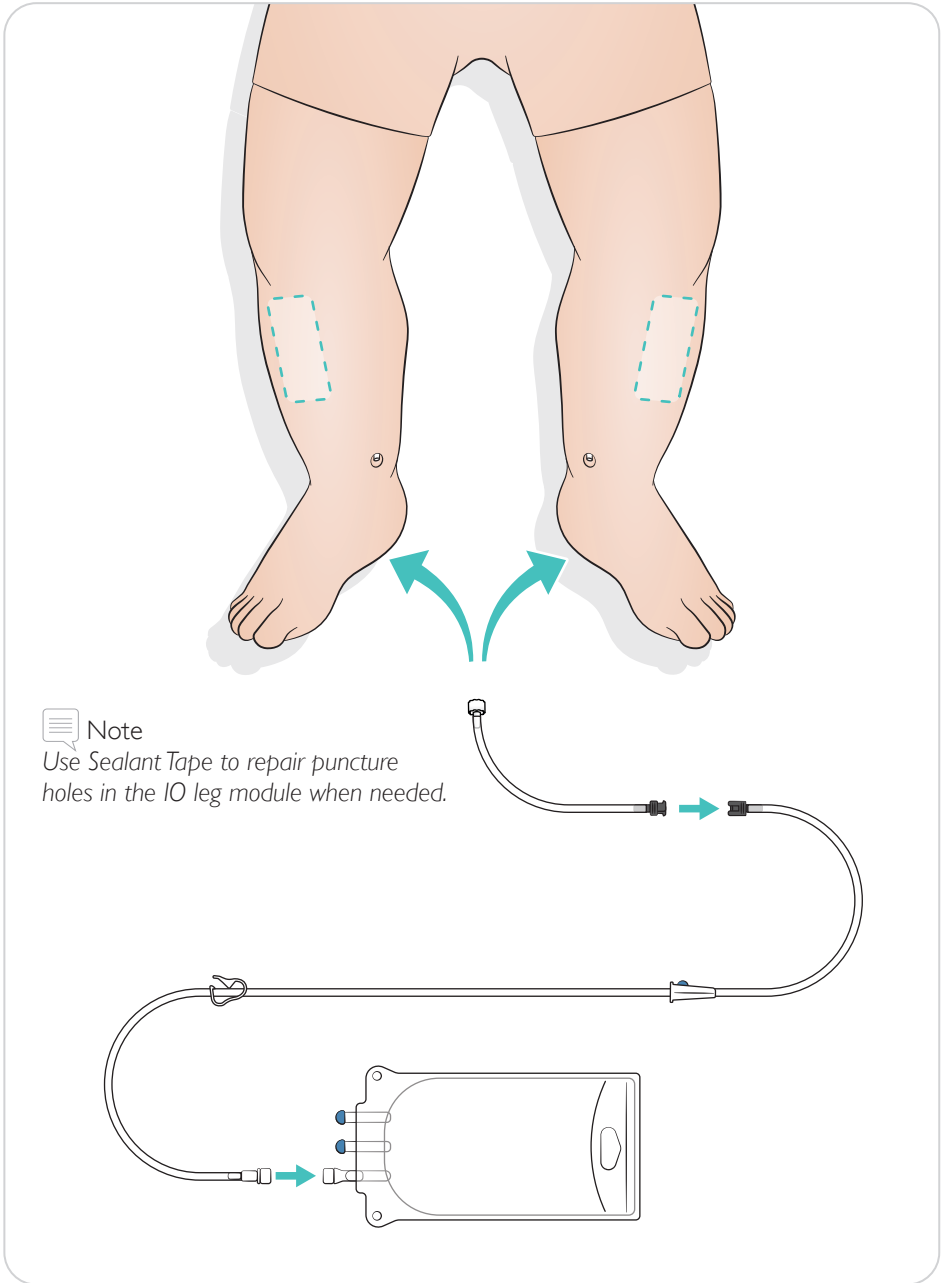

General Care

- If a training session involves the use of fluids in the pre-ported IV and IO sites, drain the fluid immediately after the training session.
- To ensure longevity, each simulator should be cleaned after each training session and a general inspection should be conducted regularly.
- To maintain simulator skins, wash hands before use and place the simulator on a clean surface.
- Use gloves during simulation scenarios. Avoid using colored plastic gloves, as they may cause discoloration of the simulator skin.

Skin

- Use a lint free cloth to remove dirt and dust.
- Clean skin with mild soap and water. Do not submerge.

Mouflage

Only use water based mouflage makeup products on the skin. Clean skin with mild soap and water. Do not submerge.

Notes

These can discolor the manikin:

- *Pigments from lipstick and pens*
- *Latex gloves*
- *Using clothes other than what is originally provided with the simulator.*

Maintenance - Changing the IO Leg

After performing IO procedures using fluids, replace the IO leg module.

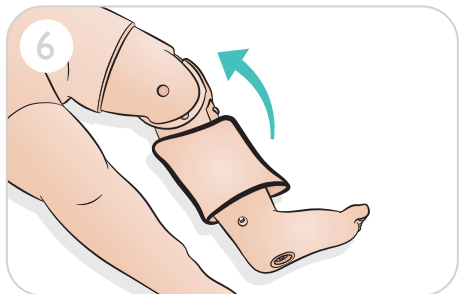
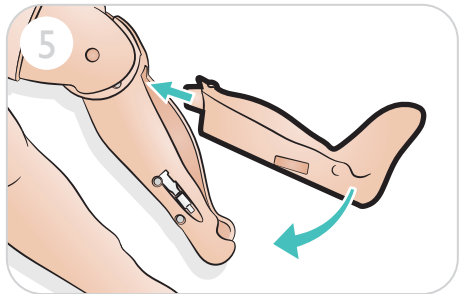
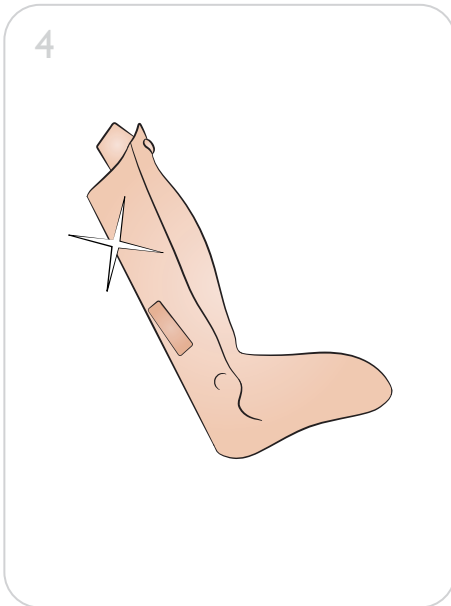
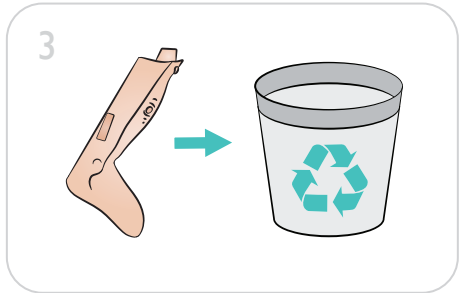
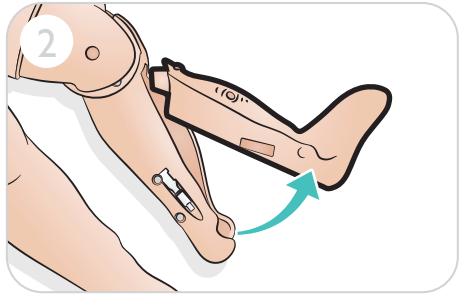
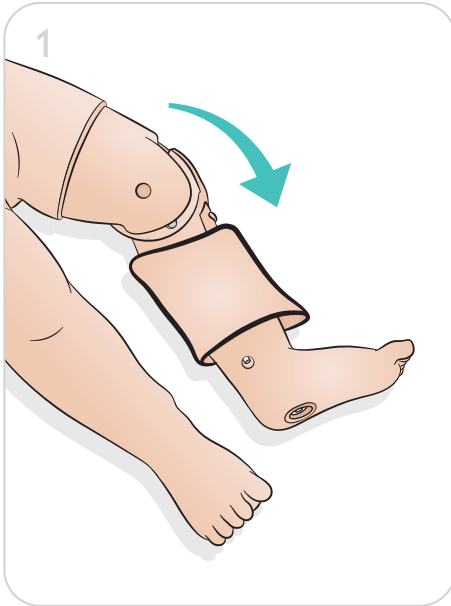

Maintenance - Changing the IV Port

Replace IV ports as needed.

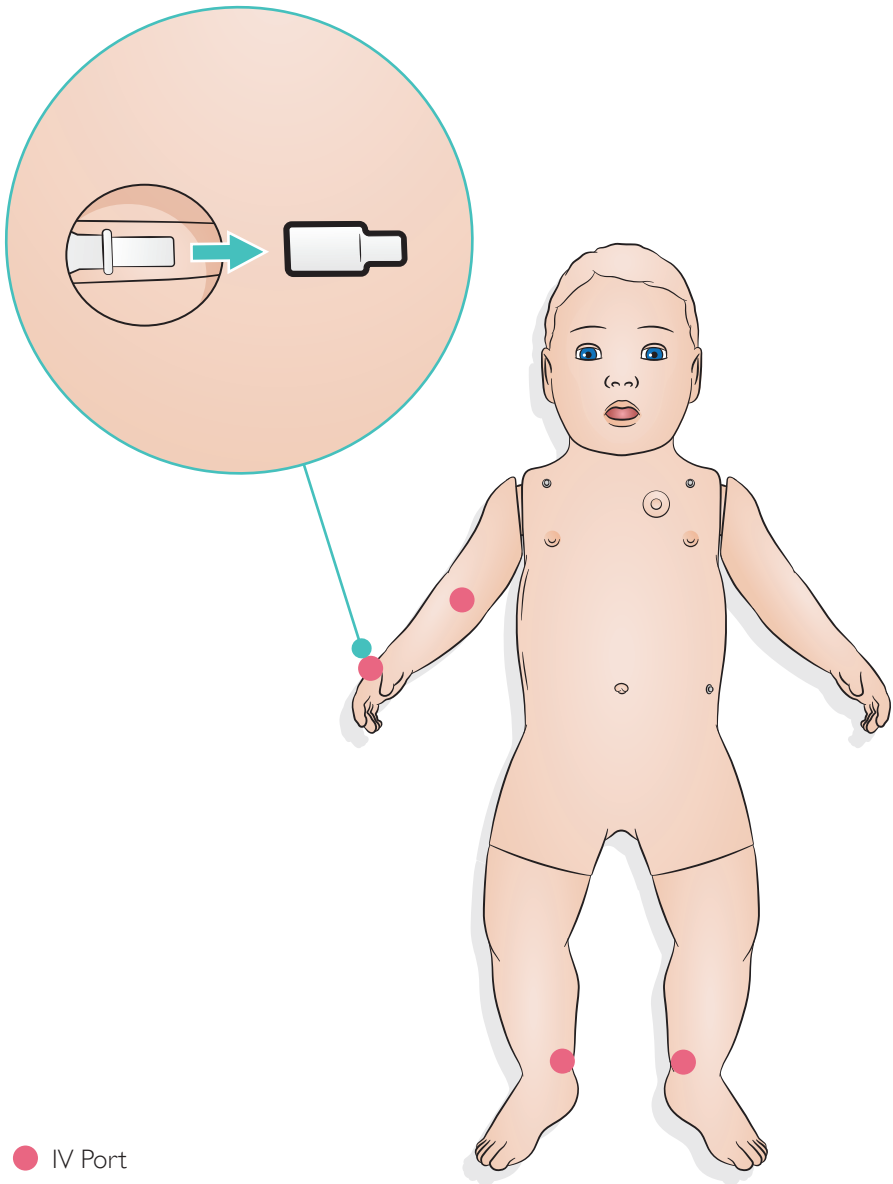

● IV Port

Maintenance - Chest Drain Module

Replace skin when damaged.

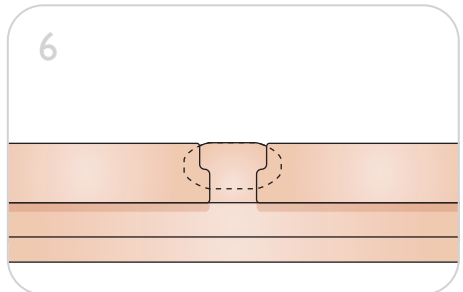
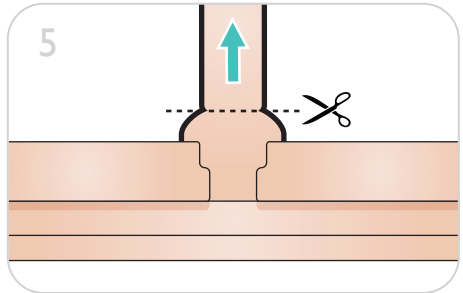
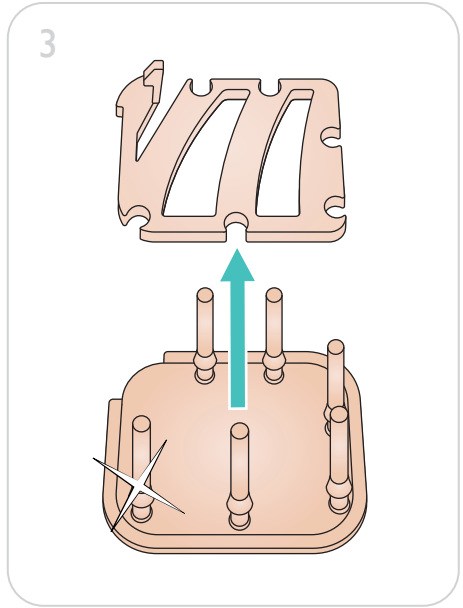
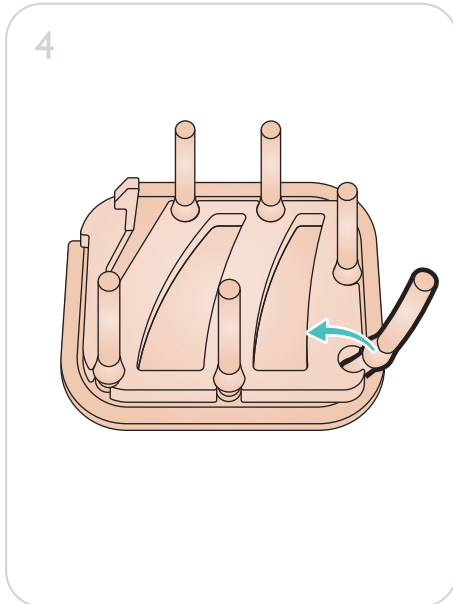
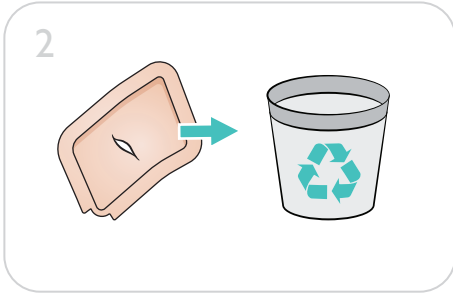
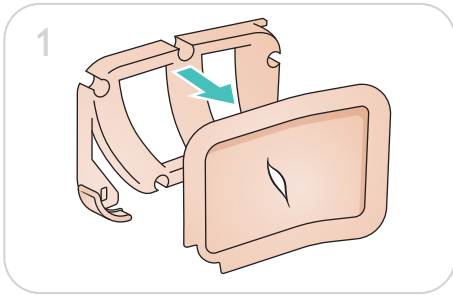

Maintenance - Needle Decompression Module

A 18 - 22 Gauge needle is recommended for decompression of the chest.

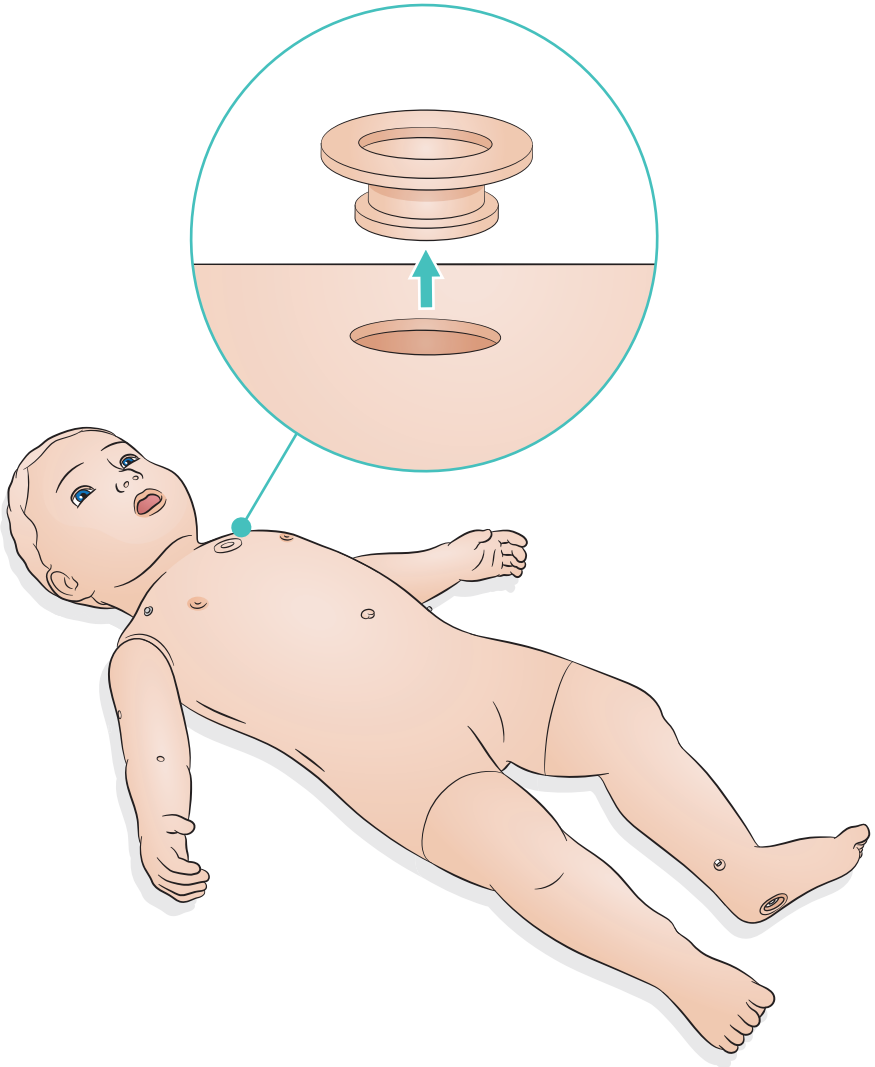





© 2018 Laerdal Medical AS. All rights reserved.

Manufacturer: Laerdal Medical AS
P.O. Box 377
Tanke Svilandsgate 30, 4002 Stavanger, Norway
T: (+47) 51 51 17 00

Printed in Norway

20-13528 Rev B

www.laerdal.com



Laerdal
helping save lives