

SimMom

自动分娩模块升级套件设置指南

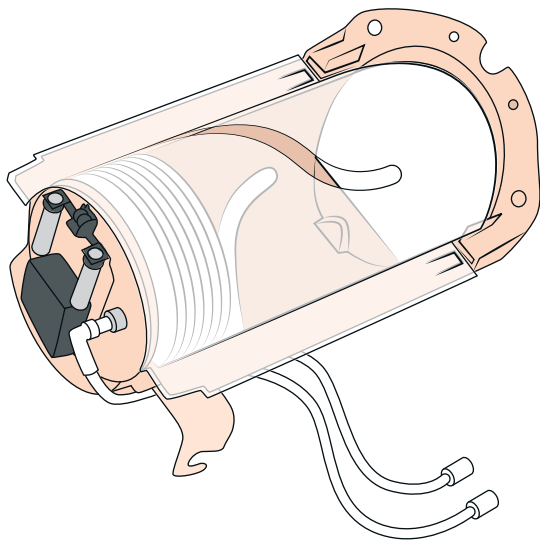

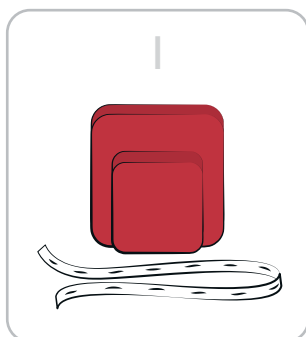
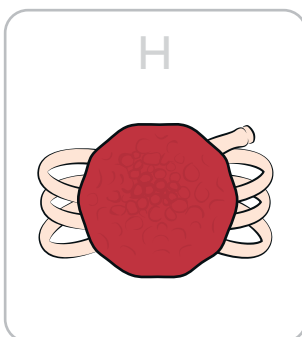
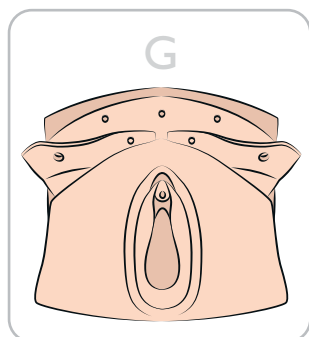
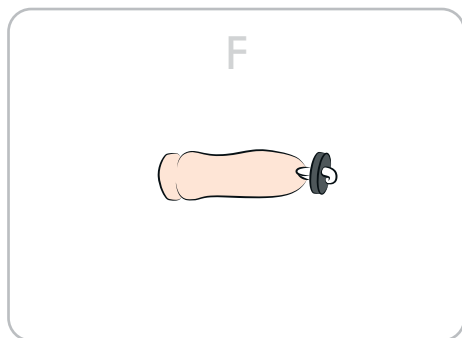
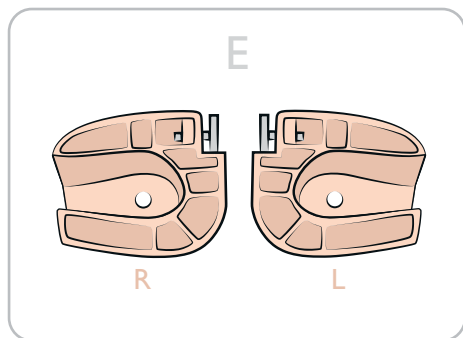
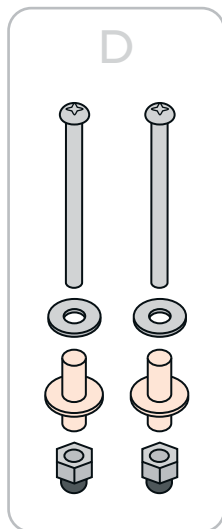
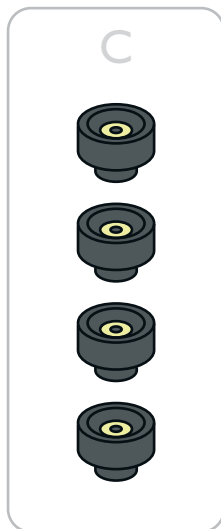
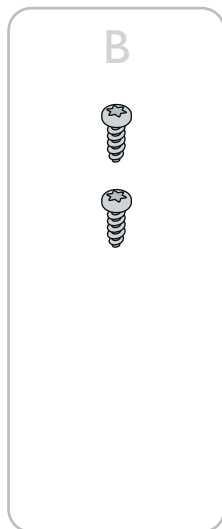
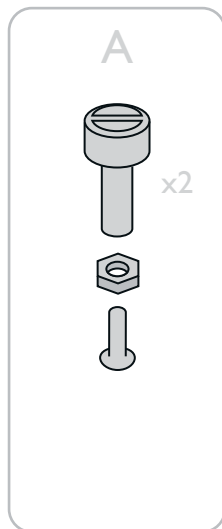

请认真按照所有步骤进行升级。否则，模拟人可能会出现性能问题且无法保修。

在升级开始前，请将双腿从躯干上卸载。使用 SimMom 内随附的升级套件和工具进行升级。

请注意自动分娩模块要求运行 LLEAP 软件。

1

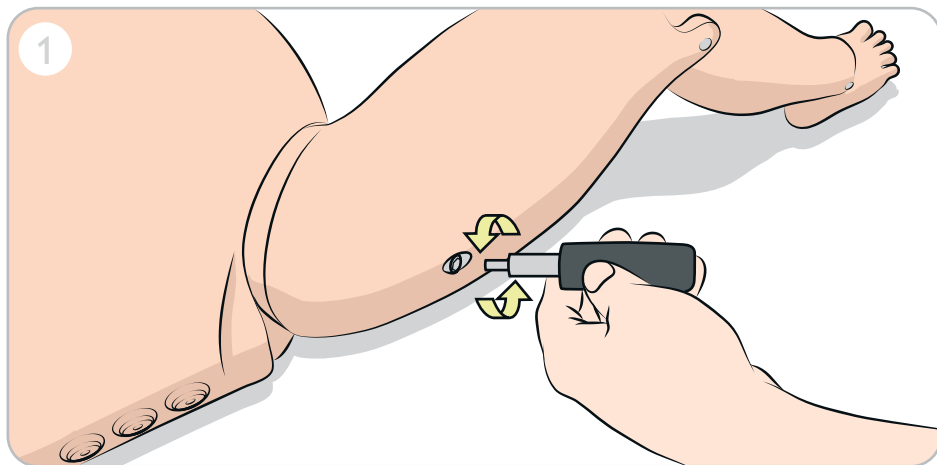

2

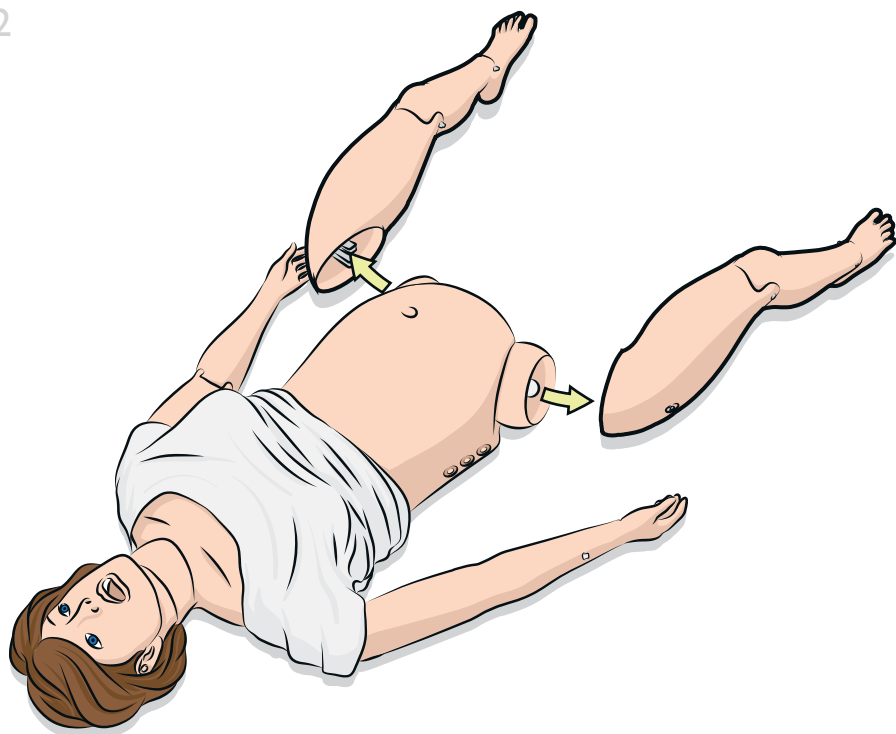

2

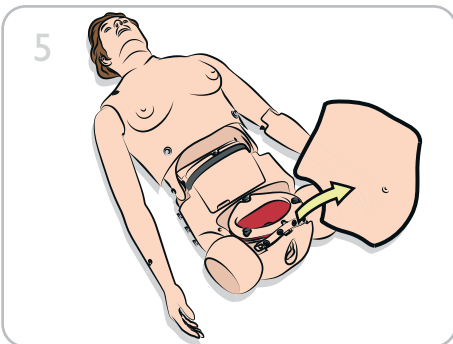
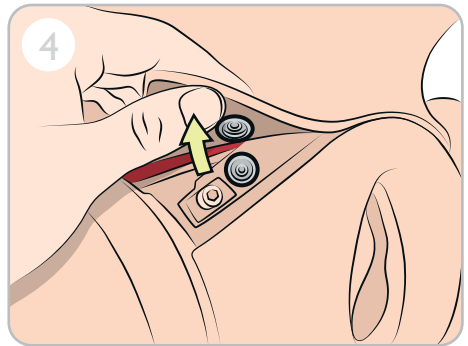
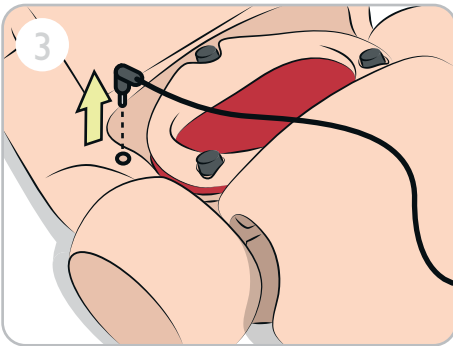
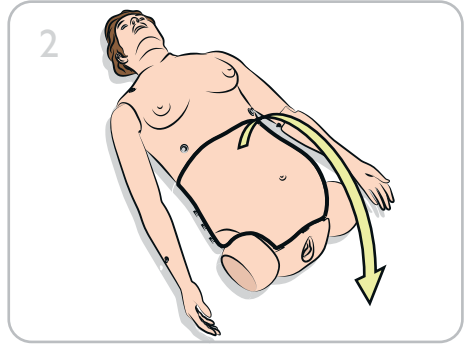
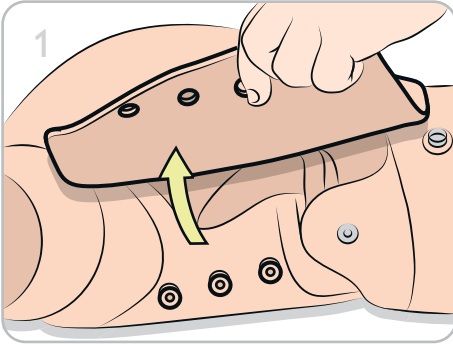

3

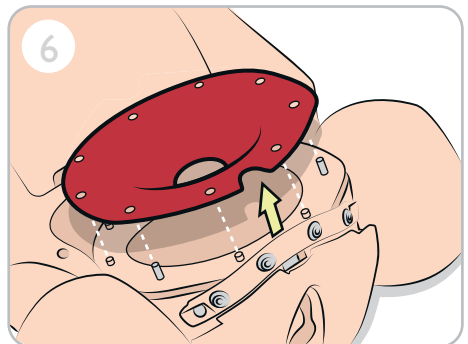
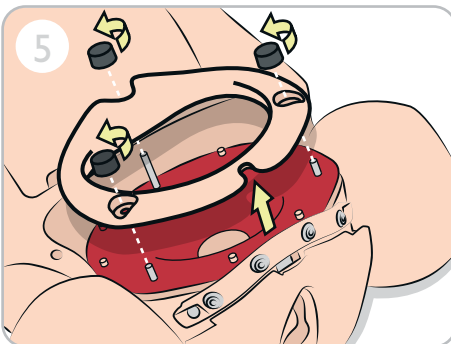
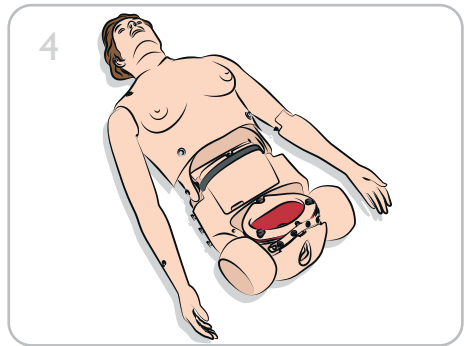
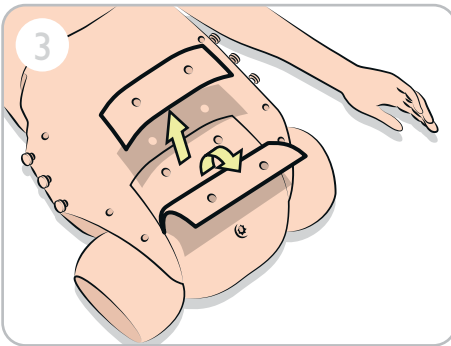
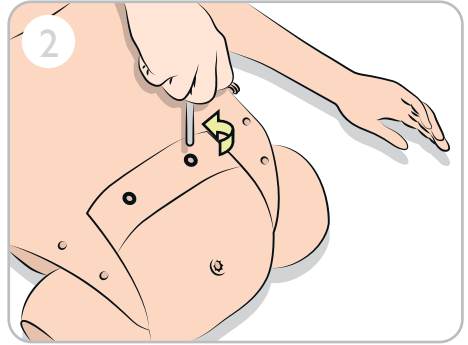
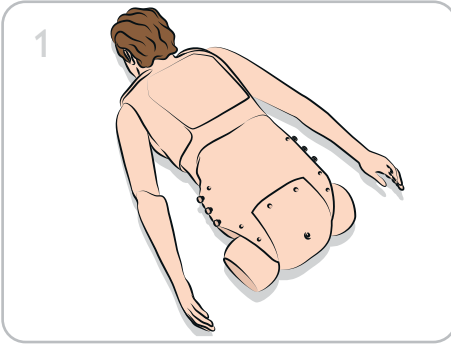

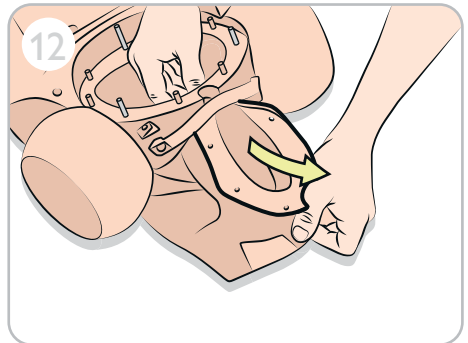
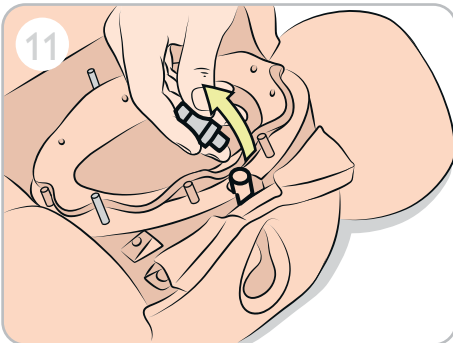
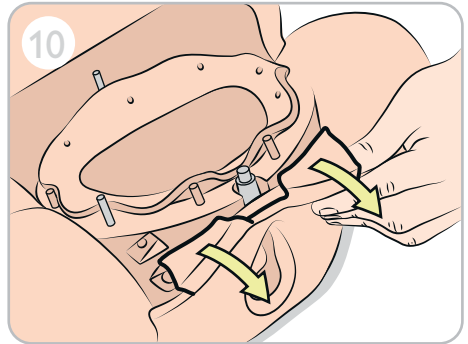
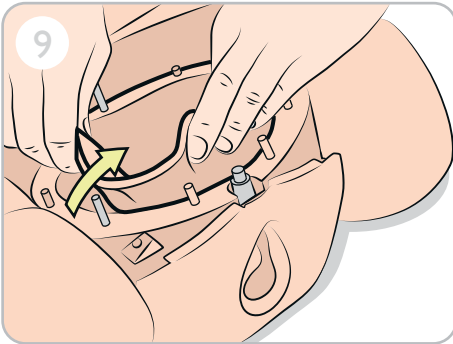
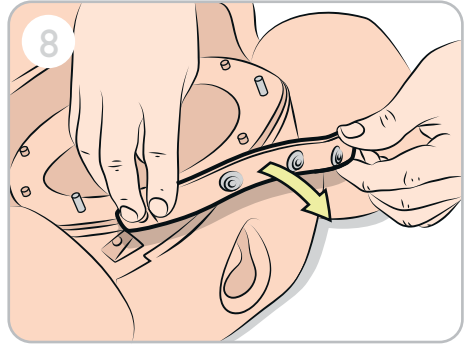
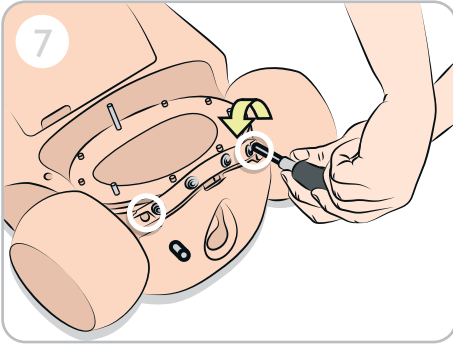

4

更换下面的长螺钉

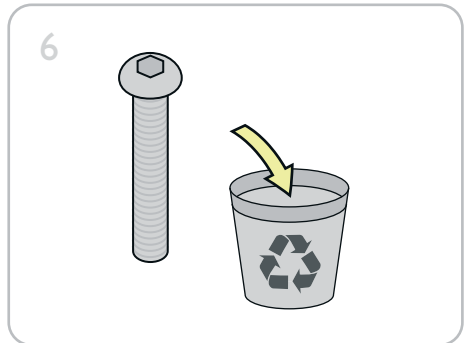
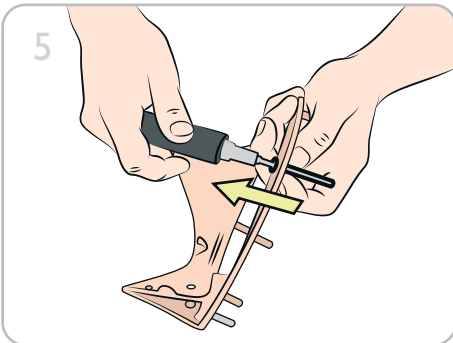
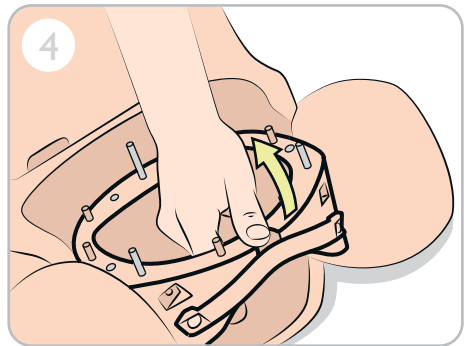
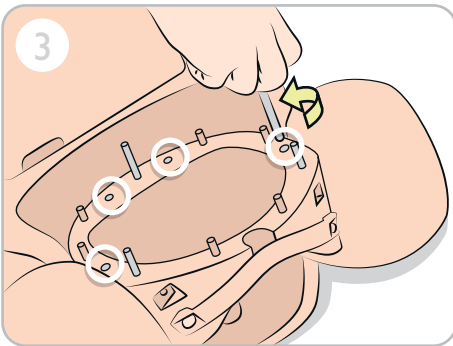
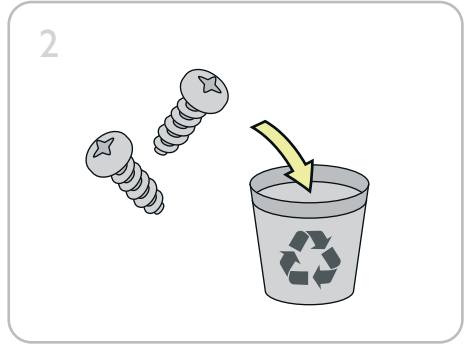
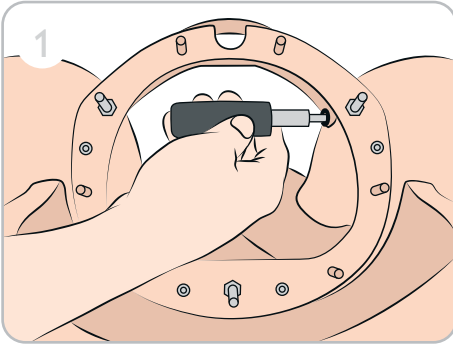

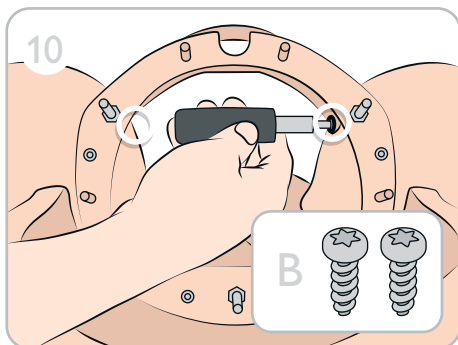
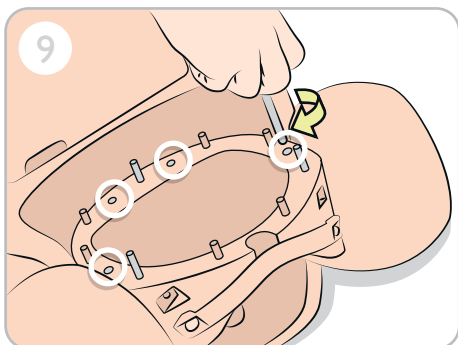
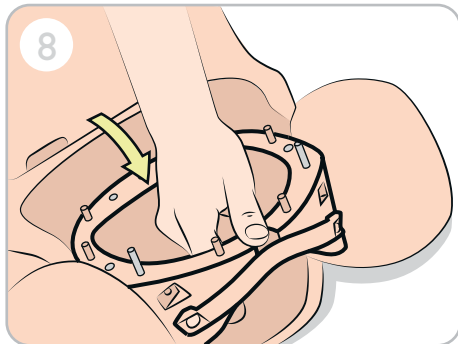
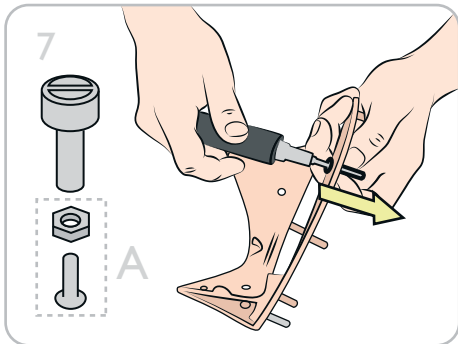

5

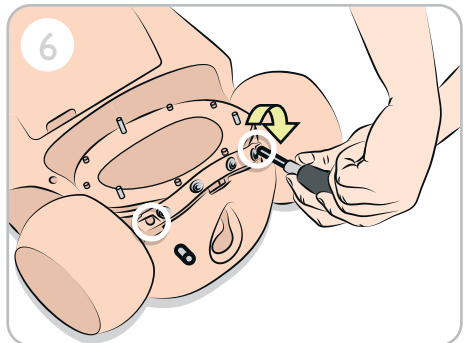
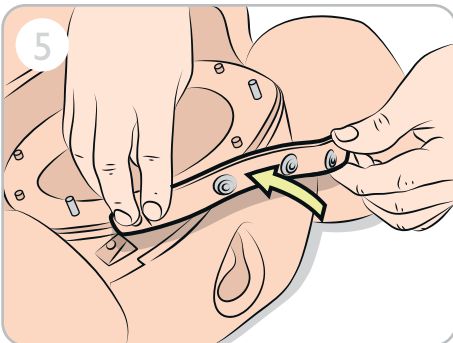
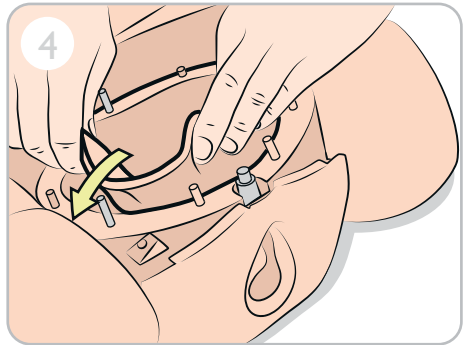
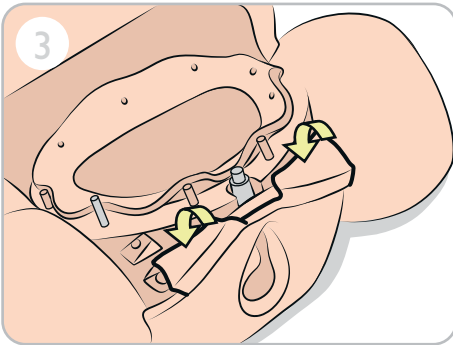
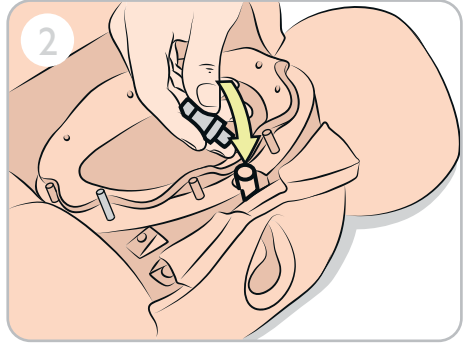
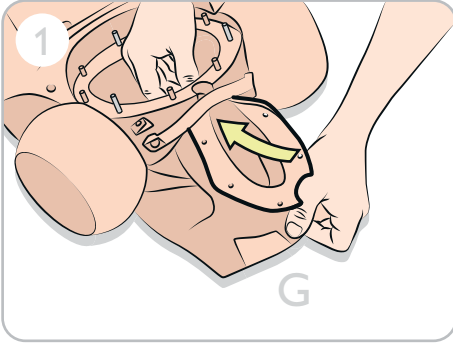

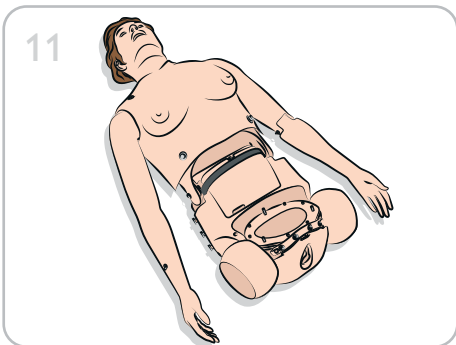
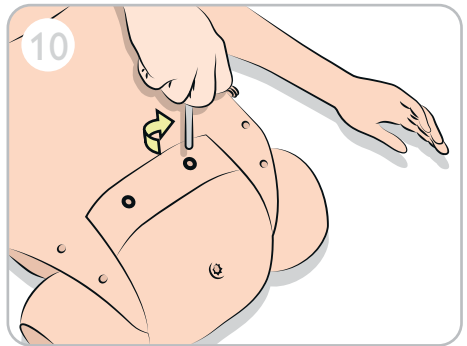
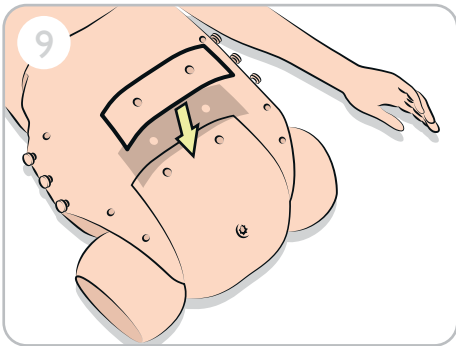
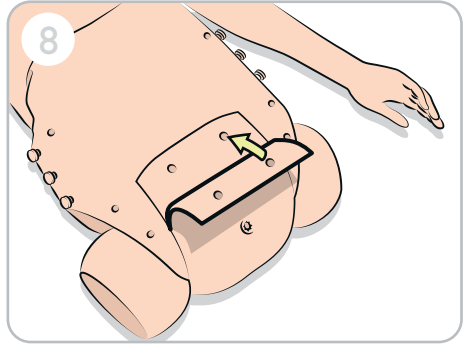
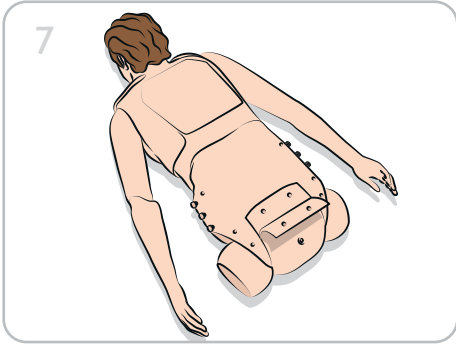

6

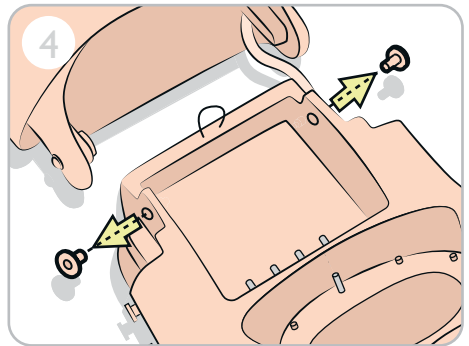
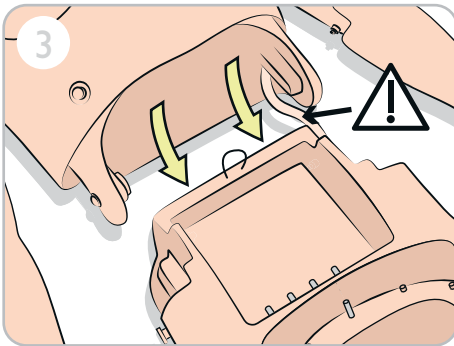
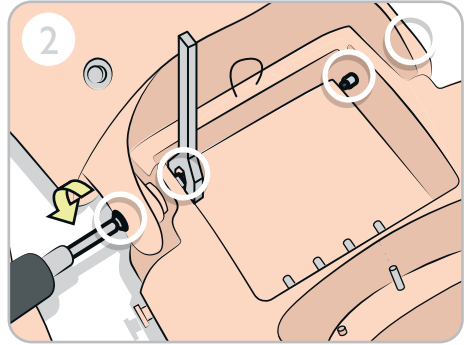
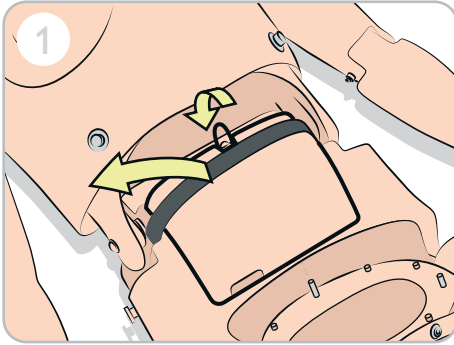

⚠ 请小心不要损坏线缆。

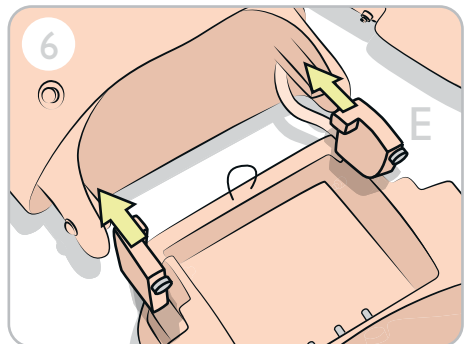
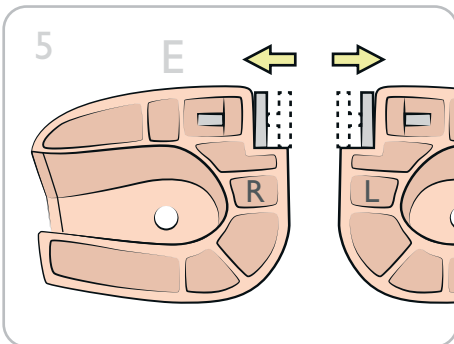

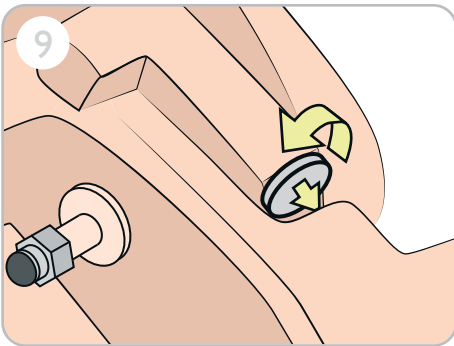
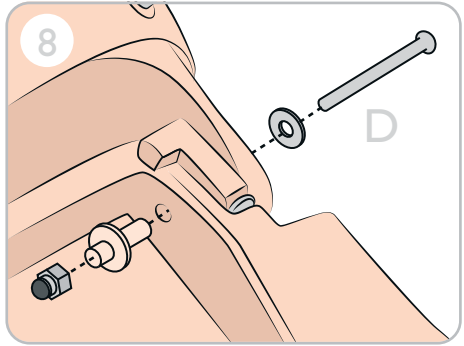
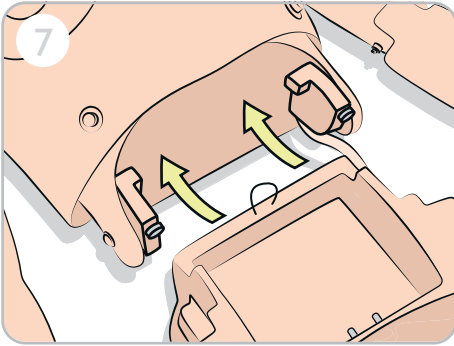

7A

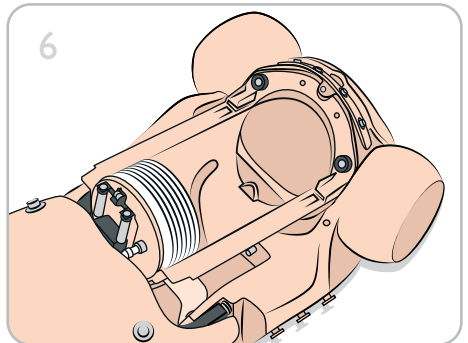
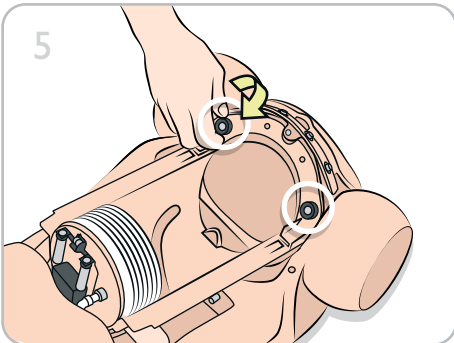
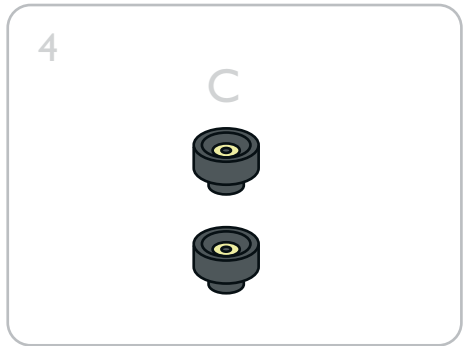
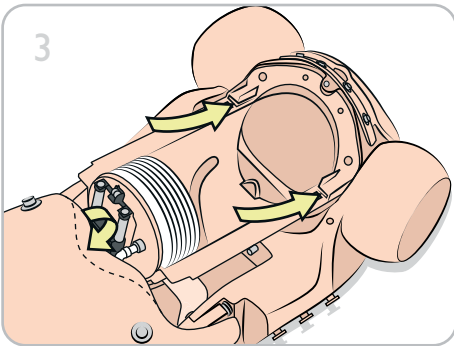
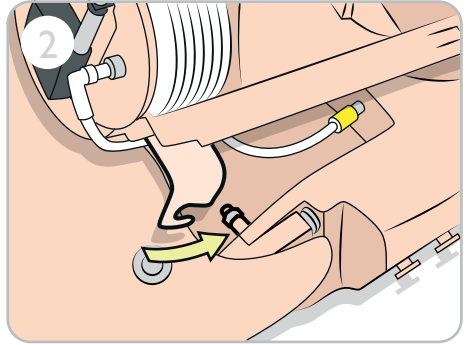
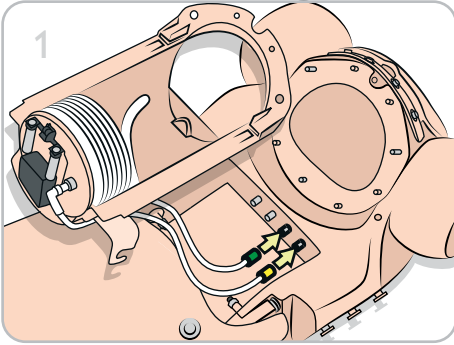

7B

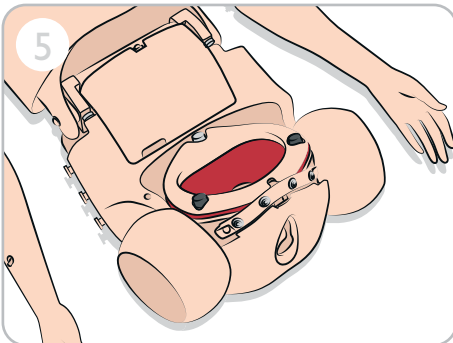
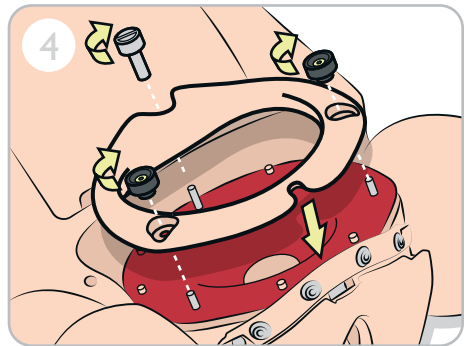
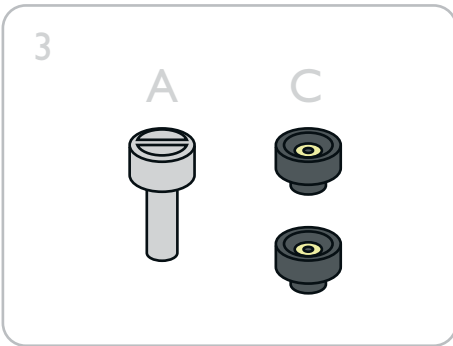
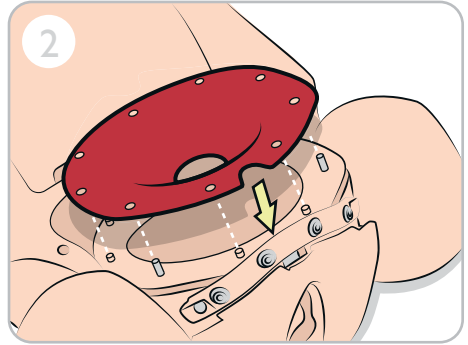
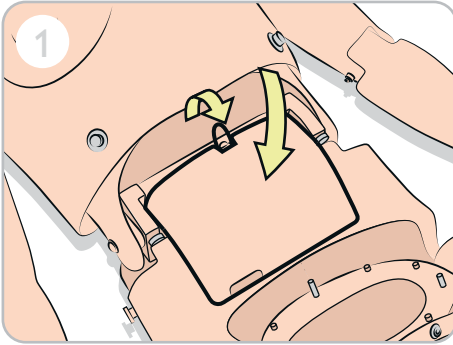

8

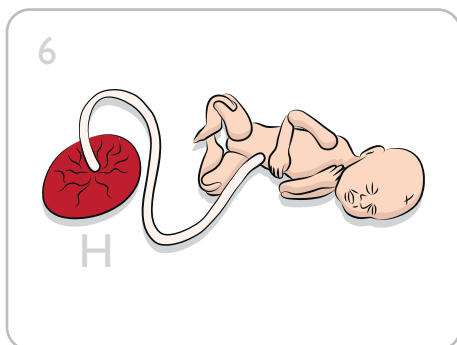
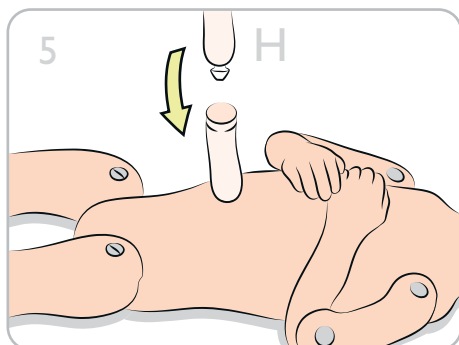
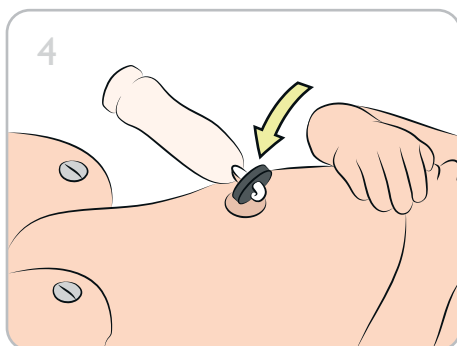
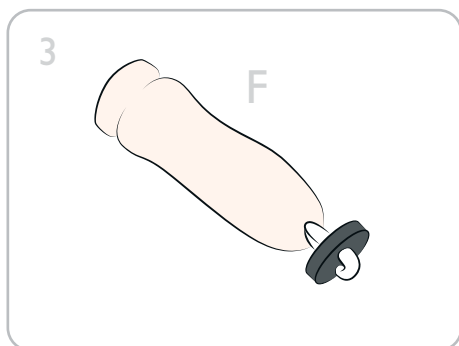
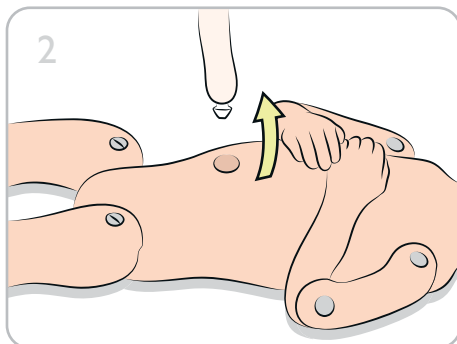
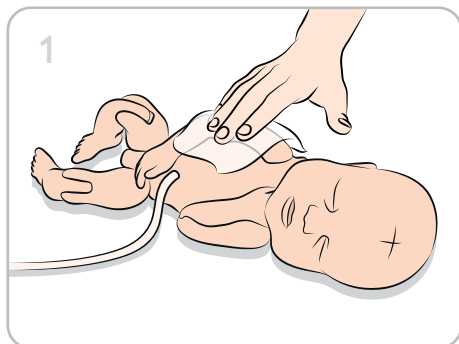

9

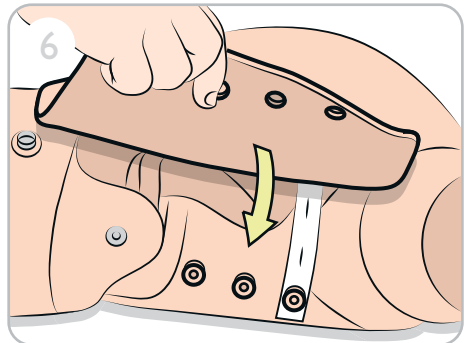
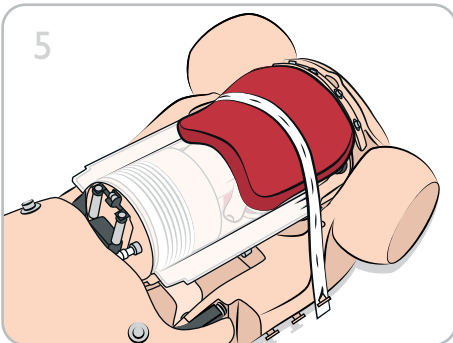
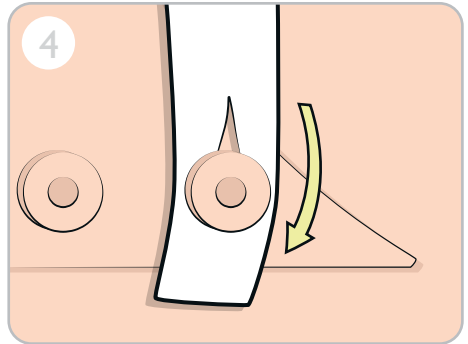
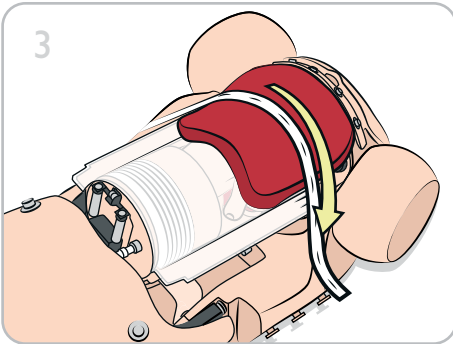
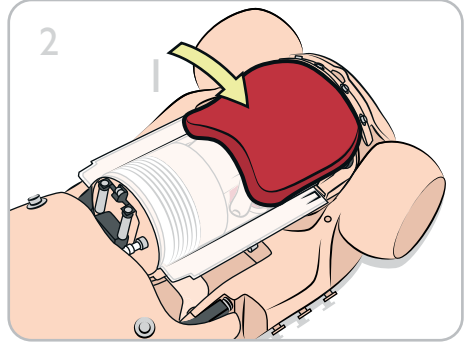
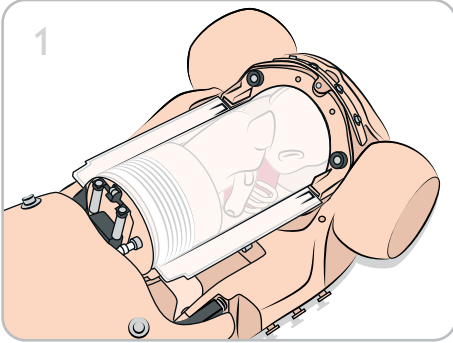





© 2014 挪度医疗公司版权所有。保留所有权利。
设备制造商：挪度医疗公司，P.O. Box 377,
Tanke Svilandsgate 30, 4002 Stavanger, Norway
电话：(+47) 5151 1700

Rev A



www.laerdal.com/cn/



Laerdal
helping save lives