

# Laerdal Suction Unit

**Directions for Use**  
Cat. No. 78 00 20 - Bemis



[www.laerdal.com](http://www.laerdal.com)



**Laerdal**  
*helping save lives*

---

## 1 Cautions and Warnings

Read these Directions for Use carefully, and become thoroughly familiar with the operation and maintenance of the LSU before using it.

The LSU should only be used by persons trained in the use of medical suction equipment.

The LSU is not suitable for use in the presence of flammable liquids or gases. There can be a danger of explosion or fire.

Do not use the LSU under environmental conditions that are outside the ranges specified under section 9.6. This can endanger safety and adversely affect operation of the device.

### **Battery:**

- To maintain satisfactory operation of the battery, it is recommended to place the LSU on continuous charge when not in use.
- The LSU must be placed on charge for a minimum of 24 hours to reach full battery capacity. The fast charging gives approx. 80% battery capacity after 3 hours (for a new battery). Please note that repetitive 3 hour charging is not recommended.
- If it is not possible to place the LSU on continuous charge when not in use, make sure the battery is charged for a minimum of 24 hours at least once a month.
- Do not store the battery when it is discharged. Always fully charge the battery before storage.

Do not block the Exhaust Outlet during use. This will lead to reduced flow and can also cause damage to the LSU.

If overflow of liquid from the Canister into the pump is suspected, the LSU must be returned for service (see section 6). Overflow of suctioned material can damage the device.

Disconnect the LSU from external power prior to cleaning. Use a minimum of liquid to prevent any electrical shock hazard.

Do not immerse the LSU or allow it to stand in water or other liquids. This might damage the device, and cause electrical hazard.

Do not pump any cleaning solution or other liquids through the vacuum pump, i.e. through the Vacuum Connector. This can damage the LSU.

Use only accessories supplied by Laerdal or one of its authorized dealers to help ensure that the LSU operates satisfactorily.

Federal law (USA) restricts the LSU to sale by or on the order of a physician.

## Contents

<b>1</b>	<b>Cautions and Warnings</b> .....	2
<b>2</b>	<b>Introduction</b> .....	4
2.1	Unpacking .....	4
2.2	Indications for Use .....	4
2.3	Contraindications .....	4
2.4	Features and Benefits .....	4
2.5	Limited Warranty .....	5
<b>3</b>	<b>Description</b> .....	6
3.1	Quick Reference Guide .....	6
3.2	User Interface .....	7
3.3	Canister .....	12
3.4	Power Sources / Connector Sockets .....	13
3.5	Automatic Power-save Function .....	13
<b>4</b>	<b>Operation</b> .....	14
4.1	Getting Started .....	14
4.2	Replace the Canister .....	15
4.3	After Use .....	16
<b>5</b>	<b>Maintenance</b> .....	16
5.1	General .....	16
5.2	Battery .....	16
5.3	Clean the Cabinet .....	16
5.4	Charge the Battery .....	17
5.5	Check the Battery Quality .....	17
5.6	Replace the Battery .....	18
<b>6</b>	<b>Servicing</b> .....	18
<b>7</b>	<b>Trouble Shooting</b> .....	19
<b>8</b>	<b>Parts List</b> .....	20
<b>9</b>	<b>Specifications</b> .....	21

---

## 2 Introduction

### 2.1 Unpacking

- Remove the LSU from its packaging and inspect all parts for damage. If there are any signs of damage or if any parts are missing, immediately notify Laerdal or one of its authorized dealers.
- Insert the battery according to section 5.6.
- Place the LSU on charge for a minimum of 24 hours to make sure you have a fully charged battery (see section 5.4).
- Perform the Device Test according to section 3.2.3.

### 2.2 Indications for Use

The LSU is a portable, electrically powered, medical suction equipment intended for field and transport use. It is intended for intermittent operation to remove secretions, blood or vomit from a patient's airway to allow ventilation. Higher vacuum levels are generally selected for oropharyngeal suctioning, and lower vacuum levels are usually selected for tracheal suctioning and the suctioning of children and infants.

### 2.3 Contraindications

None known.

### 2.4 Features and Benefits

- Splashproof, rugged and solid.
- Easy access to the tubing.
- Equipped with an internal battery that can easily be replaced without using tools.
- Charging of battery can be done directly from AC or DC mains - no external charger is needed.
- Fast charge option of 3 hours, giving approx. 80% battery capacity.
- Operation possible from internal battery and directly from AC or DC mains - no adapter is needed.
- A large combined ON/OFF switch and vacuum selector makes operation easy even with heavy-duty gloves.
- A green LED bargraph makes it easy to observe the actual vacuum level during operation.
- Another green LED bargraph indicates approx. remaining battery capacity.

---

## **2.5 Limited Warranty**

The LSU comes with five (5) year limited warranty\*. See the enclosed “Laerdal Global Warranty” for terms and conditions.

The warranty is also available at [www.laerdal.com](http://www.laerdal.com)

\* Excluding the canister, tubing systems and battery.

### 3 Description

#### 3.1 Quick Reference Guide LSU w/Disposable Canister

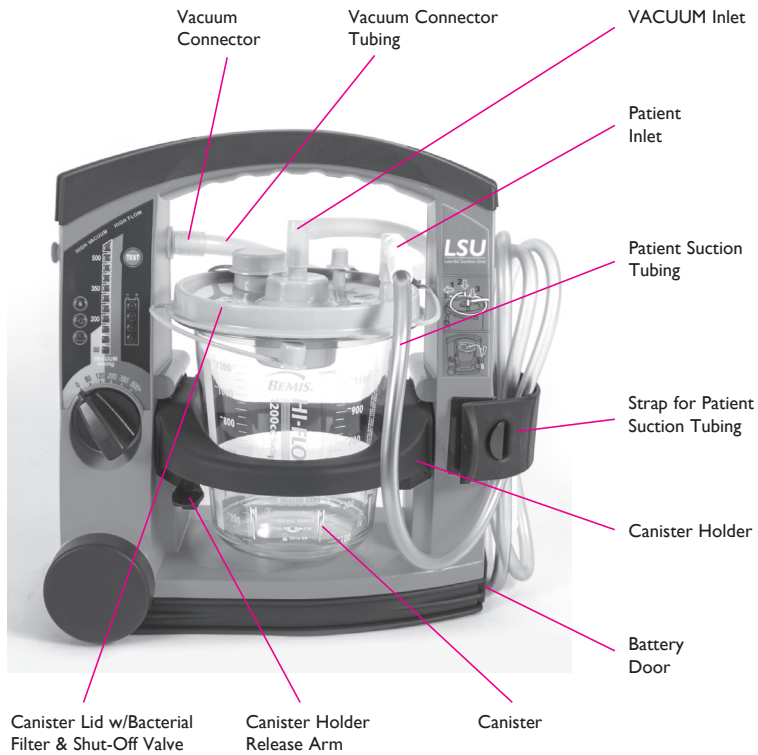

## User Interface

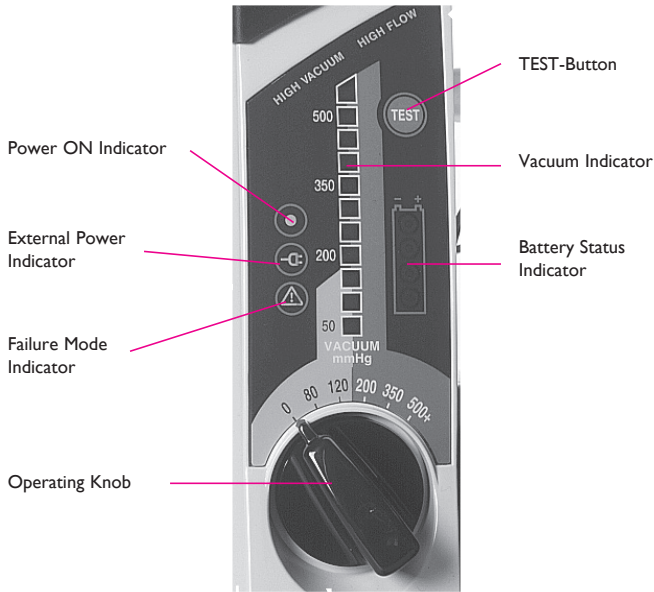

## 3.2 User Interface

### 3.2.1 Operating Knob

The Operating Knob is a combined ON/OFF switch and vacuum selector, located at the bottom of the User Interface.



The LSU is switched ON by turning the Operating Knob to the required setting. Each setting indicates the maximum achievable vacuum level for the selected position (80, 120, 200, 350, 500+ mmHg). The free air flow value changes along with the increasing vacuum settings (see section 9.4 for details). The LSU is switched OFF by resetting the Operating Knob to "0".

Even if the Operating Knob is in "0" position, voltage is present on some of the internal circuitry, when the LSU is connected to mains. To fully remove power, pull out the Power Cord.

## 3.2.2 Indicators

### 3.2.2.1 Power ON Indicator

This green LED has 3 modes:

- It is lit continuously while the LSU is switched ON.
- It flashes rapidly (approx. twice per second) during the Device Test.
- It flashes slowly (approx. once per second) while the Automatic Power-save Function is activated, if the Device Test is interrupted and when the battery is discharged.

### 3.2.2.2 External Power Indicator

This green LED is continuously lit while external AC- or DC-power is connected.

### 3.2.2.3 Failure Mode Indicator

The red LED is lit when a possible malfunction of the LSU has been detected. If lit turn the LSU OFF, and then ON again to check if the indication disappears\*. Provided that the indication does not occur again the LSU can be operated. If the Indicator continues to be lit after three OFF/ON cycles and after replacing the battery with a fully charged battery, discontinue use and return the LSU to service. (See section 6).

\*Failure Mode Indication caused by external electrical interference may occur on any digital equipment including the LSU. Such fault will usually not be repeated.

### 3.2.2.4 Vacuum Indicator

This green LED bargraph displays the actual vacuum level during operation of the LSU. Each fully lit segment represents 50 mmHg. If a segment has a weak light, this represents 25 mmHg (e.g 125 mmHg means 2 fully lit and 1 weakly lit segments).

mmHg	80	120	200	350	500
kPa	11	16	27	47	67
mBar	107	160	267	467	667

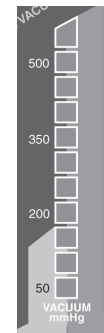

### 3.2.2.5 Battery Status Indicator

During operation from internal battery and during charging the displayed values must only be used as indications. Several parameters can influence battery capacity e.g. device settings, state of battery, temperature etc.





This green LED bargraph has 3 functions:

*During operation from internal battery - indicates approx. remaining battery capacity.*

**Note:** Immediately after turning the LSU ON and immediately after switching from external power to internal battery operation, all 4 LED's will flash for 5 seconds before the remaining battery capacity is displayed. Due to the nature of voltage based battery capacity measurement, the battery status indication may differ from unit to unit. Each battery may vary in voltage versus remaining capacity, thus allowing for variability in the reading. Other outside variables such as temperature may also affect accuracy. The indication is targeted to show battery capacity as indicated below. The graph shows how the accuracy of the indication can vary.



TYPICAL REMAINING BATTERY CAPACITY (for a new battery stored in room temperature )	OUTPUT
> 50 %	4 LEDs lit.
30 - 50%	3 LEDs lit.
20 - 30%	2 LEDs lit.
< 20%	1 LED lit.
Battery Low; (min. 1 minute of operation left based on 500+ mmHg/free flow).	1 LED flashes.

*During charging - indicates approx. achieved battery capacity.*

CAPACITY	OUTPUT*
< 75%	The LED's will be lit sequentially.
75-80%	3 LED's lit and 4th flashing.
> 80%	4 LED's lit.

**\*Note:** If no battery is installed, the battery status indicator will be fully lit for approx. 5 sec. until it is turned off.

*During the Device Test - indicates which step of the test is currently in progress or which corresponding test result is being displayed:*  
LED 1 (lower LED) lit = STEP 1, LED 2 lit = STEP 2 etc.

### 3.2.3 TEST-Button

This button allows you to run a 4-step user initiated Device Test program to identify whether the LSU operates satisfactorily, is assembled correctly or if it needs service:

- STEP 1 - Checking for occlusions in the Suction System (including canister and tubing).
- STEP 2 - Checking the vacuum build-up efficacy of the Pump System.
- STEP 3 - Checking the max. achievable vacuum level of the LSU. (reaches this level within 10 seconds).
- STEP 4 - Checking for air leakage in the Pump System (including canister and tubing).

To indicate that the LSU is in test mode, the Power ON Indicator  will flash rapidly (approx. twice per second) until you exit the test program.

#### BEFORE YOU START THE DEVICE TEST

- Before you press the TEST-Button, make sure the Patient Suction Tubing is not occluded or bent.

#### DEVICE TEST DESCRIPTION

- Press and hold the TEST-Button while setting the Operating Knob to 500+ mmHg.

**Note:** Do not release the TEST-Button until min. 2 seconds after the Operating Knob has been set to 500+ mmHg. The test will start immediately.

- As soon as LED 2 of the Battery Status Indicator comes on (takes approx. one second) fully occlude the Patient Suction Tubing.\*
- Keep the tubing occluded until LED 1 comes on. To read the test results see next page.

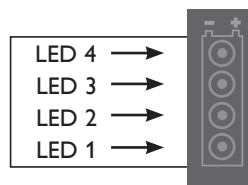

**Note:** If you need to interrupt the test and revert to normal operation, turn the Operating Knob to another position and then select the required setting.

\* If the tubing is not occluded within 2 minutes, the test will be interrupted and the Power ON Indicator will start to flash slowly (approx. once per second). To restart the test, set the Operating Knob to "0" and then start over again.

**TO DISPLAY THE TEST RESULTS:**

After the test is completed, the Vacuum Indicator will automatically display the result from STEP 1. To display the results from STEP 2, 3 and 4, simply press the TEST-Button once for each STEP. If you continue pressing the button after the STEP 4 result has been displayed, the earlier results will be repeated (STEP 1,2,3,4,1,etc.). To exit the test program, set the Operating Knob to another position.

TEST STEP DISPLAYED ON THE BATTERY STATUS INDICATOR	TEST RESULT DISPLAYED ON THE VACUUM INDICATOR	ACTION IF TEST FAILED
<b>STEP 1 - Occlusions</b>	Test Passed: ≤ 100 mmHg.	Check possible occlusions (e.g. twisted tubing) and run the Device Test again.
<b>STEP 2 - Vacuum Build-Up Efficacy - within 3 seconds</b>	Test Passed: ≥ 300 mmHg.	Check Connectors, Tubes and Canister Lid for leakage or damage. Check exhaust outlet for occlusion and run the Device Test again
<b>STEP 3 - Max. Achievable Vacuum - within 10 seconds</b>	Test Passed: ≥ 500 mmHg.	Check Connectors, Tubes and Canister Lid for leakage or damage. Check exhaust outlet for occlusion and run the Device Test again
<b>STEP 4 - Air Leakage</b>	Test Passed: ≥ 450 mmHg.	Check Connectors, Tubes and Canister Lid for leakage or damage and run the Device Test again

**Note:** If the LSU does not pass one or more of the steps in this test after suggested actions are taken, the device might need to be returned for service (see section 6).

### 3.3 Bemis™ Canister

The disposable Canister consists of:

- A 1200 ml transparent plastic Canister.
- Bacterial Filter - 99.99% DOP rated.
- Shut-Off Valve and Foam Guard seals tightly to prevent fluid overflow.

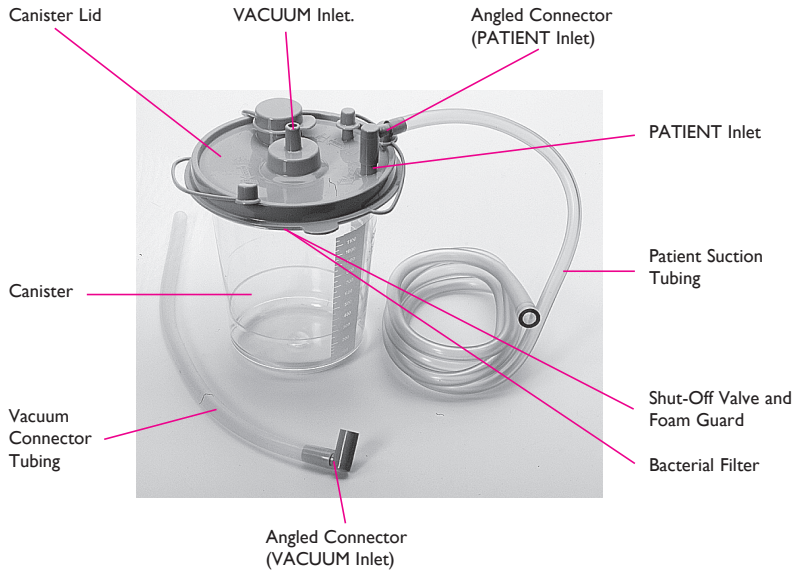

The Canister Lid contains a Shut-Off Valve that shuts off the vacuum if the Canister is full or the LSU tips over. To reset the valve, remove the Angled Connector from the VACUUM Inlet.

**Note:** All parts are disposable and must be replaced after each use.

---

### 3.4 Power Sources / Connector Sockets

The LSU is delivered with an AC Power Cord for connection to AC mains and a DC Power Cord for connection to DC mains.

The device can be operated from the internal battery, and can be operated or charged from the following external Power Sources:

- AC mains when used with the AC Power Cord: 100-240 VAC (50/60 Hz).
- DC mains when used with the DC Power Cord: 12-28 VDC.

A Wall Bracket to hold the LSU during operation and charging is available separately (see section 8).

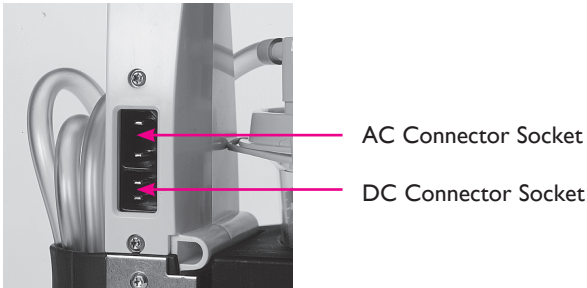

External power connection will cause the External Power Indicator  to be lit.

### 3.5 Automatic Power-save Function

The LSU has an Automatic Power-save Function that switches OFF the pump motor. While in this mode, the Power ON Indicator  will flash slowly (approx. once per second).

This function will be activated when the Operating Knob is set to 200, 350 or 500+ mmHg and the actual vacuum level has been continuously higher than 120 mmHg for 2 minutes.

To exit the Power-save Mode and revert to normal operation, set the Operating Knob to any position and then go back to required setting.

## 4. Operation

### 4.1 Getting Started

**Note:** Read all the Cautions and Warnings listed in section 1 thoroughly before you use the LSU.

1. Check that no parts are missing and that all parts are clean.
2. If you decide to operate the LSU from external power, connect either external AC- or DC-power to the LSU as described in section 3.4. If decide to operate the LSU from internal battery, check that battery is installed.
3. Ensure the Patient Suction Tubing is securely connected to the PATIENT Inlet on the Canister Lid. Proceed as follows:



4. Release the Patient Suction Tubing by releasing the Strap.
5. The LSU should be operated in the upright position to prevent overflow of suctioned material.
6. Set the Operating Knob to the required vacuum level, and the LSU will automatically be switched ON and start to operate. The green Power ON Indicator  is continuously lit while the LSU is switched ON.

## 4.2 Replace the Canister

**Note:** It is recommended to replace the Canister when it is 3/4 full. When liquid reaches the top of the Canister, the LSU will not suction any more liquid. If overflow of liquid from the Canister into the pump is suspected, the LSU must be returned for service (see section 6). Overflow of suctioned material can damage the device.

1. To remove the Canister, proceed as follows:



2. Disconnect the Angled Connector from the VACUUM Inlet on the Lid. Connect the “suction end” of the Patient Suction Tubing to the VACUUM Inlet to avoid spillage.

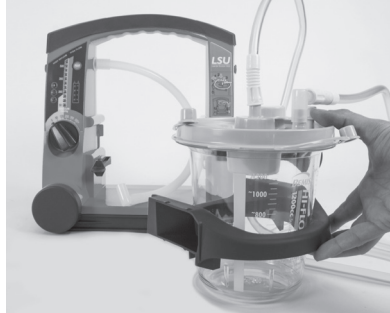

3. To release the Canister Holder, press down the Canister Holder Release Arm while sliding the Holder towards you. Remove the Canister from the Holder.
4. Safely dispose of the contents of the Canister according to local protocols.
5. Replace parts according to section 3.3.
6. Install the Canister in the Holder, slide the Holder into position and connect tubing to the Canister.

### 4.3 After Use

- When suction is complete, set the Vacuum Switch to “0” and inspect all parts for damage or excessive wear. Replace parts if necessary.
- Clean the LSU according to section 5.3.
- Perform the Device Test according to section 3.2.3.
- Place the LSU on charge (see section 5.4).

## 5. Maintenance

### 5.1 General

- Make sure the maintenance instructions under section 4.3 are followed.
- If the device is not in frequent use (i.e. less than once a month), the Device Test should be performed both on a monthly basis and after each use.

### 5.2 Battery

- To maintain satisfactory operation of the battery, it is recommended to place the LSU on continuous charge when not in use.
- Replace the battery when it does not pass the Battery Quality Check (see section 5.5 for details), or after 3 years.
- Do not store the LSU with an discharged battery.

### 5.3 Clean the Cabinet

**Warning:** Disconnect the LSU from external power prior to cleaning. Use a minimum of liquid to prevent any electrical shock hazard. Do not immerse the LSU or allow it to stand in water or other liquids. This can damage the device, and cause electrical shock resulting in injury to persons.

- Use a cloth or sponge that is dampened with a mild detergent (hand dishwashing liquid or similar) to clean the external surfaces of the LSU. Use a detergent that is compatible with the materials listed under section 9.7, and follow the detergent manufacturer’s instructions.
- Use a cloth or sponge dampened with water and wipe the surfaces again.
- Dry the surfaces using a clean cloth or a paper towel.



## 5.4 Charge the Battery

The internal rechargeable battery can be charged directly from external AC- or DC-power as described in section 3.4. No external charger is needed. To charge the battery, proceed as follows:

1. Make sure the Operating Knob is set to "0". Connect either external AC- or DC-power to the LSU and charging will start automatically.
2. During charging the Battery Status Indicator will indicate approx. achieved battery capacity (see section 3.2.2.5 for details).
3. The LSU must be placed on charge for a minimum of 24 hours to reach full battery capacity. The fast charging gives approx.80% capacity after 3 hours (for a new battery). Repetitive charging for only 3 hours is not recommended.



### Note:

- To maintain satisfactory operation of the battery, it is recommended to place the LSU on continuous charge immediately after use.
- It is recommended to always fully charge the battery. Repetitive charging to a lower capacity level will reduce battery life.
- If it is not possible to place the LSU on continuous charge when not in use, make sure the battery is charged for a minimum of 24 hours at least once a month.
- Do not store the battery when it is discharged. Always fully charge the battery before storage.
- The recommended ambient temperature for charging is from 15°C to 25°C (59°F to 77°F).
- The battery will not be charged when the LSU is in operation.
- If no battery is installed, the battery status indicator will be fully lit for approx. 5 sec. until it is turned off.

## 5.5 Check the Battery Quality

If poor battery quality is suspected, charge the battery for a minimum of 24 hours and then perform the following test without connection to external power:

- Run the Device Test and then let the LSU operate continuously at 500+ mmHg/free flow for 20 minutes.
- If the LSU stops before completing the 20 minutes, the battery should be discarded.

## 5.6 Replace the Battery

**Note:** Use only batteries recommended by Laerdal or one of its authorized dealers.

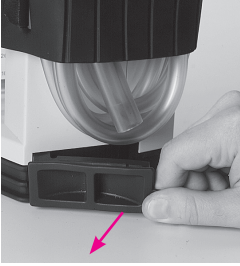

1. Open the Battery Door.

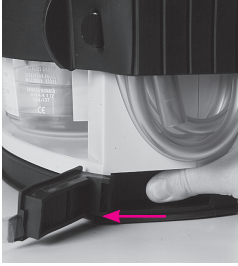

2. To remove the battery, push and move it slightly to the left and then release.



3. Withdraw the battery from the LSU.\*

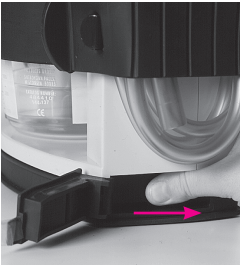

4. To insert a battery, push it fully in and then to the right to lock it.

5. Close the Battery Door.

6. After inserting the battery, place the LSU on charge unless a fully charged battery is inserted.

## 6. Servicing

There are no user serviceable parts inside the cabinet. Do not open the cabinet. Refer servicing to personnel qualified by Laerdal, or to Laerdal or one of its authorized dealers.

\*If you are discarding the battery, dispose of safely according to local protocols.

## 7. Trouble Shooting

FAULT	CONDITION	ACTION
The LSU does not operate with the AC or DC Power Cord connected.	External Power Indicator is not lit when the Operating Knob is set to "0".	Check power cord connections and the external AC- or DC-power source.
	External Power Indicator is lit.	The LSU must be returned for service (see section 6).
The LSU cannot be operated from the internal battery.	Power ON Indicator is OFF.	Check that battery is installed.
		Place the LSU on charge.
		If still faulty after charging completed, remove and replace the battery (see section 5.6).
The LSU operates, but little or no suction available.	Floater valve is closed.	Unplug the Filter/Vacuum Tubing to release the vacuum
	Canister full.	Remove and replace the Canister (see section 4.2).
	Poor vacuum connection between Pump Unit and Canister.	Install the Vacuum Connector Tubing correctly.
	Patient Suction Tubing twisted or blocked.	Untwist the Patient Suction Tubing and/or clear blockage or replace the tubing.
Battery Status Indicator is not ON.	Battery is not charged.	Check power cord connections and that battery is installed
Vacuum Indicator indicates more than 100 mmHg with free air flow	Tube(s) is kinked or twisted	Straighten / untwist the tube(s).

## 8. Parts List

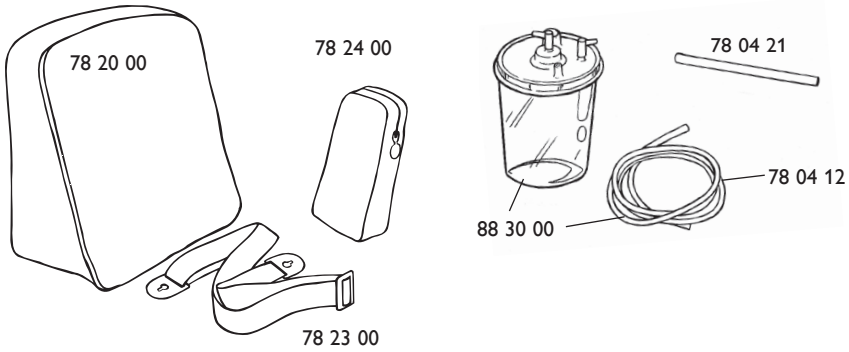

### Catalogue Number

### Description

78 00 20 LSU w/Bemis Canister (not illustrated)

### Consumables

88 30 00 Disposable Bemis Canister & Suction Tubing (12/pkg.)

78 04 12 Disposable Patient Tubing

78 04 21 Vacuum Connector Tubing, Bemis 40 cm

### Accessories

78 20 00 Carrying Bag (full covering)

78 26 00 Wall Bracket w/DC-Power Cord (not illustrated)

78 26 10 Wall Bracket w/AC-Power Cord US (not illustrated)

78 26 40 Wall Bracket w/Power Cord (not illustrated)

78 23 00 Shoulder Strap

78 24 00 Side Pouch

78 04 40 External charger kit (not illustrated)

### Parts

78 03 00 Direction for Use (not illustrated)

78 04 20 Bemis Canister Holder

78 04 33 Strap for Tubing

78 04 32 Release Arm

78 02 00 DC-Power Cord

78 02 10 AC-Power Cord US

78 04 00 LSU Battery - Lead Acid

78 08 00 LSU Battery - NiMH

78 04 34 Hook for strap (not illustrated)

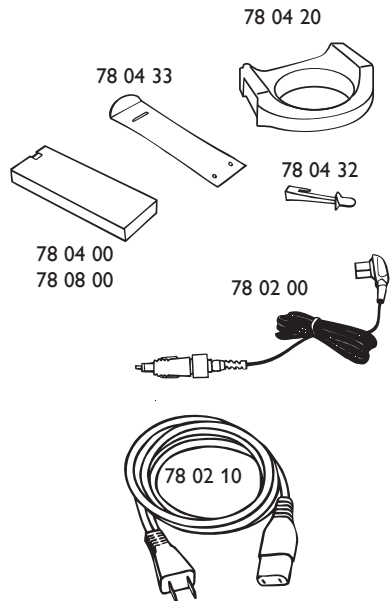

**Note:** Parts or product configurations are subject to change without notice.

## 9. Specifications

### 9.1 Classification

Electrically powered medical suction equipment for field and transport use, according to ISO10079-1.

High vacuum/high flow.

Not suitable for use in the presence of flammable liquids or gases.

Internally powered/class II equipment type BF, according to IEC 60601-1.

Protection class IP34D\*, according to IEC 60529.

- \* - Protected against solid foreign objects of 2,5 mm Ø and greater.
- Protected against splashing water
- Protected against access with a wire.

### 9.2 General tolerance

Overall tolerance  $\pm$  5%

### 9.3 Physical Characteristics

Size: 315 mm (12,4 in) x 330 mm (13 in) x 160 mm (6,3 in), (h x w x d)  
Weight: 4kg (8.9 lbs) (including battery).  
Canister Capacity: 1200 ml.  
Patient Suction Tubing (non-sterile): 0.25 in. (6.5 mm) inside diameter x 72 in. (1.8 m) length.

### 9.4 Operation

Approx. free air flow at different settings:

80 mmHg	120 mmHg	200 mmHg	350 mm Hg	500+mmHg
12 sl/min.	16 sl/min.	20 sl/min.	25 sl/min.	> 30 sl/min.

sl = litre at standard atmospheric pressure and temperature.

Approx. battery operation time at different settings: (free air flow) ( $\pm$ 10%)

80 mmHg	120 mmHg	200 mmHg	350 mm Hg	500+mmHg
3 h 45 min.	2 h	1 h 20 min.	50 min.	30 min.

Approx noise levels at different settings: (free air flow)

80 mmHg	120 mmHg	200 mmHg	350 mm Hg	500+mmHg
46 dBA	48 dBA	51 dBA	55 dBA	57 dBA

Vacuum - Max.: > 500 mmHg (67 kPa).  
Vacuum - Range: 80 - 500+ mmHg (11 - 67 kPa).  
Vacuum Indicator accuracy: +/- 5% of full scale.

### 9.5 Power Requirements

Operating/charging:	100-240 VAC +10%/-15%, 50-60 +/- 3 Hz (100-240 VAC), or 12-28 VDC +/-10%.*
Battery:	12 VDC 2 Ah, Sealed Lead-Acid, rechargeable. 12 VDC 2 Ah, NiMH, rechargeable.
Charging Time:	3 hours for approx. 80% battery capacity, 24 hours for fully charged.
Vehicle Supply:	12-28 VDC nominal.
Fuses:	The LSU has no fuses to be replaced by the user (see section 6).

\*The external AC power source must be able to deliver a current of min. 1A and the external DC power min. 6A, if not the LSU may switch to battery operation.

### 9.6 Environmental Conditions

Operating/Charging Temperature:	0° C (32°F) to + 40° C (104° F).
Recommended Charging Temperature:	15°C (59°F) to + 25°C (77°F ).
Long Term Storage Temperature:	0° C (32°F) to + 40° C (104° F).
Max. 24 hour Storage Temperature:	-30° C (-22°F) to + 70° C (158° F).
Humidity (Operating & Storage):	5-95% RH non-condensing

### 9.7 Material Chart

Cabinet front:	Poly Carbonate/Acrylonitrile Butadiene Styrene (PC/ABS)
Protector for front:	Styrene Ethylene Betyl Styrene (SEBS)
Cabinet back:	PC/ABS
Cabinet base w/Protector:	PC/ABS + SEBS
Battery door:	SEBS
Connector retainer for battery:	Poly Oxy Methylene (POM)
Operating Knob:	POM
Rotor for Vacuum Switch knob:	PC/ABS
Manifold for vacuum:	POM
Canister Holder:	Polypropylen(PP)
Handle w/Protector:	PC/ABS + SEBS
Manifold for exhaust:	POM
Strap for patient suction tubing:	SEBS
Canister Holder Release Arm:	POM
User Interface	Polyester
Vacuum Connector:	Silicone
Vacuum Connector Tubing:	Silicone
Disposable Canister:	General Purpose Polystyrene (GPPS)
Disposable Canister Lid:	High-Densisty Polyethylene (HDPE)
Patient Suction Tubing:	Polyvinylchloride "flexible" (PVC)
Wallbracket:	Aluminium + Steel + POM + PE + PVC
Full covering Carrying Bag:	PVC coated Polyester
Side Pouch:	PVC coated Polyester

## 9.8 Symbols

 Direct Current.

 Alternating Current.

 Class II Equipment, according to IEC 60601-1.

 Type BF applied part, according to IEC 60601-1.

**IP34D** Protection class ref. IEC 529

 This product is in compliance with the essential requirements of MDD 93/42/EEC.

 Do not reuse.

 Date of production.

 See Directions for Use

 This product complies with the following ANSI/UL and CSA standards of section 9.9.

## 9.9 Standards

### CSA Standards:

CAN/CSA-C22.2 No.:	0-M91	General Requirements - Canadian Electrical Code, part II.
CAN/CSA-C22.2 No.:	601.1-M90	Medical Electrical Equipment Part I: General Requirements for Safety.
CAN/CSA-C22.2 No.:	601.1S1-94	Supplement No. I-94 to CAN/CSA-C22.2 No. 601.1-M90 - Medical Electrical Equipment - Part I: General Requirements for Safety.

### US Standards:

UL Standard No.:	60601-1	Medical Electrical Equipment.
------------------	---------	-------------------------------

Made in Norway by:  
LAERDAL MEDICAL AS, Norway  
P.O. Box 377, N-4002 Stavanger  
Tel. +47 51 51 17 00  
Fax +47 51 52 35 57

Distributed in USA by:  
LAERDAL MEDICAL CORPORATION  
167 Myers Corners Road  
P.O. Box 1840, Wappingers Falls  
New York 12590-8840  
Tel. +1 (800) 431-1055, +1 (845) 297-7770  
Fax +1 (800) 227-1143, +1 (845) 298-4545

© 2013 Laerdal Medical AS. All rights reserved.

6791 Rev E



**Laerdal**  
*helping save lives*